

CASTERS DESIGNED FOR MEDICAL EQUIPMENT
QUIET • CLEAN • SMOOTH



ANTIMICROBIAL CASTERS & WHEELS

How Does It Work?

The compound used in our antimicrobial wheels, thread guards and forks is designed to suppress the growth of a variety of destructive and odor causing microbes including bacteria, molds, mildew, and fungi. The active ingredients neutralize the ability of microbes to function, grow and reproduce.

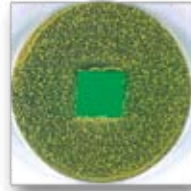

Standard wheel material

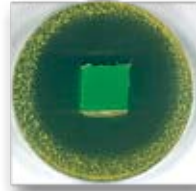

Wheel with antimicrobial compound



How long does the protection last?

Antimicrobial wheels are engineered to be effective against microbes for the life of the wheel. The agent remains stored in the polymer and is gradually released to the surface of the wheel.

Will scratches, tread wear or wax buildup diminish the effectiveness?

No. Antimicrobial wheel protection is not a coating on the surface of the wheel, thread guard or fork. It is an integral part of the product. Abrasion, chips or scratches will not impact the effectiveness in any way. Not even wax buildup on the wheel can impair the bacteria fighting performance.

Does the antimicrobial compound eliminate the need for cleaning?

No. Although antimicrobial compound provides an added level of protection, this does not eliminate the need for normal cleaning practices. They are designed to work in conjunction with

and enhance your ongoing program. Good hygiene practices should always be observed.

Is the antimicrobial compound safe?

Yes. The active ingredients have undergone extensive laboratory testing and have been proven safe. The active ingredient has a history of hospital use for more than 25 years and is used in a broad range of popular personal care products, such as antimicrobial soap, toothpaste and deodorant. It is registered with the US Environmental Protection Agency (EPA), and products with this material have been approved by the US Food & Drug Administration (FDA), the European Union (EU), the National Sanitation Foundation (NSF) and other regulatory authorities around the world.



NG Antimicrobial



ANTISTATIC CASTERS

Electronic equipment can be damaged by the electrostatic discharge of a simple human touch. Damage caused by this discharge is a very costly and frustrating to the medical industry. MedCaster antistatic casters and wheels can help minimize the risk of electrostatic discharge. Our NA and PA casters and wheels conforms to CEN standards with resistance values < 10,000 ohms (measured at 500V DC, with minimum output of 50 V DC at 1,000 ohms resistance).



NA Antistatic



PA Antistatic

CONTENTS

MedCaster Inc. is focused on the manufacturing and supply of casters and wheels to the Medical and Pharmaceutical industries. Our broad line of products and expertise allows us to meet our customer's needs. MedCaster can also design and produce casters and wheels that meet your specific requirements such as custom colors or other specifications. Please contact us toll free at 1-866-462-9700 or email us at info@medcaster.com.

CASTER FITTING GUIDE.....	4-5
MEDCASTER MODEL NUMBERING SYSTEM.....	6

DOUBLE WHEEL CASTERS

DUAL WHEEL CASTERS (DW).....	7
TWIN WHEEL CASTERS (TW)	8
NEW! GREY TECH CASTERS (GT).....	9
MEDIMASTER (MM)	10
NEW! NON-MAGNETIC CASTERS (NM).....	11
TWIN-MED (TM).....	12-13
KICK-STOP (KS)	14
NEW! NEOTEQ CHROME DUAL (DN).....	15

MEDCASTER MULTI-PURPOSE CASTERS

NEOTEQ (CN)	16-17
NEW! RAZER (RZ).....	18-21
CHROME HOSPITAL (CH)	22-33
CHROME STEEL (CS)	34-43
STAINLESS STEEL (SS) 1-1/4" TREAD WIDTH.....	44-49
STAINLESS STEEL (SS) 2" DIAMETER	50-52

MEDCASTER NYLON/PLASTIC CASTERS

NYLON (NG) LIGHT GREY (ND) DARK GREY (NB) BLACK	53-65
NYLON PLUS STAINLESS (NS)	66-73
PLASTIC (PG).....	74-81
PLASTIC ANTISTATIC (PA)	82-83

MEDCASTER HOSPITAL BED CASTERS

HOSPITAL BED CASTER INTRODUCTION AND ACCESSORIES	84
MED-BED (MB)	85
HOSPITAL BED PLASTIC (HP)	86-87
HOSPITAL BED CHROME (HC)	88-89
HOSPITAL BED STAINLESS STEEL (HS).....	90-91
NEW! MED-ULTRA (MU).....	92

MEDCASTER SPECIALTY CASTERS & ACCESSORIES

SOLUS TECH (ST).....	93
WHEELS	94-96
WHEEL CHAIR CASTER (WC) (WW)	97
BUMPERS.....	98
SPECIALTY / INCHES TO METRIC CONVERSION.....	99



CASTER FITTINGS GUIDE



HOLLOW KINGPIN

Suffix No.	Dimensions	DW	CN	CH	CS	SS	NG	NS	PG	PA	RZ
HK01	1/2 ID	✓		✓	✓	✓	✓	✓	✓	✓	
HK02	12mm ID								✓		
HK04	7/16 ID		✓								✓



EXPANDING ADAPTER STEMS

Suffix No.	Dimensions	CH	CS	SS	NG	NS	PG	PA
------------	------------	----	----	----	----	----	----	----

Round Nylon Expanding Adapters

XRN1	3/4 x 2-1/4	✓	✓	✓	✓	✓	✓	✓
XRN2	13/16 x 2-1/4	✓	✓	✓	✓	✓	✓	✓
XRN3	7/8 x 2-1/4 round	✓	✓	✓	✓	✓	✓	✓
XRN4	1 x 2-1/4	✓	✓	✓	✓	✓	✓	✓

Round Rubber Expanding Adapters

XRR1	3/4 x 2-1/4	✓	✓	✓	✓	✓	✓	✓
XRR2	7/8 x 2-1/4	✓	✓	✓	✓	✓	✓	✓
XRR3	1 x 2-1/4	✓	✓	✓	✓	✓	✓	✓
XRR4	1-1/8 x 2-1/4	✓	✓	✓	✓	✓	✓	✓
XRR5	1-1/4 x 2-1/4	✓	✓	✓	✓	✓	✓	✓
XRR6	1-3/8 x 2-1/4	✓	✓	✓	✓	✓	✓	✓
XRR7	1-1/2 x 2-1/4	✓	✓	✓	✓	✓	✓	✓
XRR8	1-5/8 x 2-1/4	✓	✓	✓	✓	✓	✓	✓

Round Zamac Expanding Adapters

XRZ1	21/32 x 2-1/4	✓	✓		✓	✓	✓	✓
XRZ2	3/4 x 2-1/4	✓	✓		✓	✓	✓	✓
XRZ3	7/8 x 2-1/4	✓	✓		✓	✓	✓	✓
XRZ4	1 x 2-1/4	✓	✓		✓	✓	✓	✓
XRZ5	1-3/32 x 2-1/4	✓	✓		✓	✓	✓	✓

Square Zamac Expanding Adapters

XSZ1	25/32 x 2-1/4	✓	✓		✓	✓	✓	✓
------	---------------	---	---	--	---	---	---	---



CENTRAL LOCKING STEMS

Suffix No.	Dimensions	MB	HP	HC	HS	MU
CL01	27.8mm x 98mm*	✓	✓	✓	✓	✓
CL02	32mm x 54mm	✓	✓	✓	✓	✓
CL03	27.8mm x 98mm	✓	✓	✓	✓	✓
CL04	32mm x 54mm	✓	✓	✓	✓	✓

*HP, HC, HS, MU are 27.8 mm x 96mm.



SWIVEL TOP PLATES

Suffix No.	Dimensions	DW	CN	CH	CS	SS	NG	NS	PG	PA	RZ	GT	TM	DN
TP01	2-1/2" x 3-5/8"	✓		✓	✓	✓	✓	✓	✓	✓			✓	✓
TP02	1-1/4" x 2-3/8"		✓											
TP03	4" x 4-1/2"													
TP04	2.65" x 3"			✓		✓								
TP05	2.12" x 2.12"										✓			
TP06	2.36" x 2.36"										✓			
TP07	1-1/2" x 1-1/2"											✓		
TP08	2-3/4" x 2-5/8"											✓		
TP09	2-3/16" x 2-9/16"											✓		

Caster Series

CH	Chrome Hospital
CN	Chrome Neoteq
CS	Chrome Steel
DW	Dual wheel
DN	Neoteq Dual
GT	Grey Tech
HC	Hospital Bed Chrome
HP	Hospital Bed Plastic
HS	Hospital Bed Stainless
KS	Kick Stop
MB	Med-Bed Casters
MM	MediMaster
NM	Non-Magnetic
MU	Med-Ultra
NA	Nylon Antistatic
ND	Nylon Dark Gray
NG	Nylon Light Gray
NK	Nylon Black
NS	Nylon Plus Stainless
PA	Plastic Antistatic
PD	Plastic Dark Gray
PG	Plastic Light Gray
RZ	Razer
SS	Stainless Steel
ST	Solus Tech
TM	Twin-Med
TW	Twin Wheel
WC	Wheel Chair Casters
WO	Misc. Wheel Only
WW	Wheel Chair Wheels

Continue next page

CASTER FITTINGS GUIDE

ROUND STEMS



Suffix No.	Dimensions	CH	CS	NG	PG	PA	MB	HP	HC	HS
RS01	22mm x 45mm	✓	✓	✓	✓	✓				
RS02	25.4mm x 45mm	✓	✓	✓	✓	✓				
RS03	27.8mm x 45mm	✓	✓	✓	✓	✓	✓	✓	✓	✓
RS04	20.5mm x 45mm	✓	✓	✓	✓	✓				
RS05	32mm x 45mm	✓	✓	✓	✓	✓	✓	✓	✓	✓

SQUARE STEMS



Suffix No.	Dimensions	CH	CS	NG	PG	PA
SQ01	3/4 x 2, no holes	✓	✓	✓	✓	✓
SQ02	1 x 1.75, 3 holes	✓	✓	✓	✓	✓
SQ03	.850 x 2.2, grip ring	✓	✓	✓	✓	✓

GRIP RING STEMS



Suffix No.	Dimensions	TW	CN	CH	CS	NG	NS	PG	PA	RZ	GT	NM
GR01	7/16 x 7/8 round	✓	✓							✓	✓	✓
GR02	7/16 x 1-7/16 round	✓		✓	✓	✓				✓	✓	✓
GR03	3/8 x 7/8 round											
GR04	5/8 x 1-5/8 round			✓	✓	✓		✓	✓			
GR05	3/4 x 1-5/8 round			✓	✓	✓		✓	✓			
GR06	7/8 x 2 round			✓				✓	✓			
GR07	1 x 1-7/8 round			✓	✓	✓		✓	✓			
GR08	7/16 x 1-29/32 round							✓	✓	✓	✓	
GR09	.845 x 2-3/16 round			✓	✓	✓		✓	✓			
GR10	7/16 x 1-3/8 round			✓	✓	✓				✓		
GR11	.845 x 2-3/16 round stainless						✓					
GR12	7/16 x 1-15/16 round					✓						

THREADED STEMS



Suffix No.	Dimensions	TW	CN	CH	CS	SS	NG	NS	PG	PA	ST	KS	MM	TM	WC	RZ	GT	NM
TS01	1/2-13NC x 3/4			✓	✓		✓		✓	✓								
TS02	1/2-13NC x 1	✓		✓	✓		✓		✓	✓				✓			✓	
TS03	1/2-13NC x 1-1/2	✓		✓	✓		✓		✓	✓				✓			✓	
TS04	1/2-13NC x 2			✓	✓		✓		✓	✓								
TS05	7/16-14NC x 1-3/4			✓	✓		✓		✓	✓								
TS06	3/8-16NC x 1	✓	✓													✓	✓	
TS07	M12 x 1			✓	✓		✓		✓	✓								
TS11	1/2-13NC x 3/4 stainless			✓	✓		✓		✓	✓								
TS12	1/2-13NC x 1 stainless			✓	✓		✓		✓	✓								
TS13	1/2-13NC x 1-1/2 stainless			✓	✓		✓		✓	✓								
TS14	1/2-13NC x 2 stainless			✓	✓		✓		✓	✓								
TS15	M10 X 19/32										✓	✓					✓	
TS16	M12 X 25/32										✓	✓						
TS17	M14 x 7/8										✓	✓						
TS18	M16 x 25/32										✓	✓						
TS19	M12 x 1-1/8										✓	✓						
TS20	M10 x 43/64									✓							✓	
TS21	M12 x 60MM			✓			✓							✓				
TS22	1/2-13 x 2-11/16			✓			✓											
TS23	M12 X 15MM												✓					
TS24	3/8-16NC x 3/4"																✓	✓
TS25	3/8-16NC x 1-1/2"																✓	✓

Caster Series

- CH** Chrome Hospital
- CN** Chrome Neoteq
- CS** Chrome Steel
- DW** Dual wheel
- DN** Neoteq Dual
- GT** Grey Tech
- HC** Hospital Bed Chrome
- HP** Hospital Bed Plastic
- HS** Hospital Bed Stainless
- KS** Kick Stop
- MB** Med-Bed Casters
- MM** MediMaster
- NM** Non-Magnetic
- MU** Med-Ultra
- NA** Nylon Antistatic
- ND** Nylon Dark Gray
- NG** Nylon Light Gray
- NK** Nylon Black
- NS** Nylon Plus Stainless
- PA** Plastic Antistatic
- PD** Plastic Dark Gray
- PG** Plastic Light Gray
- RZ** Razer
- SS** Stainless Steel
- ST** Solus Tech
- TM** Twin-Med
- TW** Twin Wheel
- WC** Wheel Chair Casters
- WO** Misc. Wheel Only
- WW** Wheel Chair Wheels

MEDCASTER MODEL NUMBERING SYSTEM

Below example is a Nylon Light Grey (NG) caster that has a 5" diameter QuickStart wheel with a dark grey tread, thread guard and Precision Ball bearing. The tread width is 1-1/4" wide. The fork type is swivel. The fitting type is threaded stem (1/2-13 x 1-1/2").

NG-05QDP-125-SW-TS03

Caster Series	Wheel Diameter	Wheel Type	Bearing Type	Tread Width	Fork Type	Fitting Type	Fitting Code
CH Chrome Hospital	01 1	AM Anti-Microbial TPR	A Annular	025 .25	DL Directional Lock	GR Grip Ring	See page 3-4 for stem codes
CN Chrome Neoteq	02 2	AP Anti-static Polyurethane	B Ball	050 .50	DT Direction/Total Comb.	HK Hollow Kingpin	
CS Chrome Steel	03 3	AR Anti-static Rubber	D Delrin	075 .75	RB Rigid Brake	OS Octagon Stem	
DW Dual wheel	35 3.5	AT Anti-Static TPR	N Plain, Nylon	100 1	RG Rigid	RS Round Stem	
DN Neoteq Dual	04 4	HR High Temp Rubber	O Plain Bore	125 1.25	SB Side Brake	SP Special	
GT Grey Tech	05 5	CR Conductive Rubber	P Precision	150 1.5	SW Swivel	SQ Square Stem	
HC Hospital Bed Chrome	06 6	NR Neoprene Rubber	R Roller	200 2	TB Top Brake	CL System Stem	
HP Hospital Bed Plastic	07 7	NY Nylon	S Stainless Roller		TL Total Lock	TP Top Plate	
HS Hospital Bed Stainless	7.5 7.5	PB Polyurethane Black	X Stainless Precision			TS Threaded Stem	
KS Kick Stop	08 8	PH Phenolic				XR Expanding Round	
MB Med-Bed Casters	24 24	PP Polyolefin				XS Expanding Square	
MM MediMaster		PS Polyurethane Solid					
NM Non-Magnetic		PY Polyurethane TPU					
MU Med-Ultra		QB QuickStart (dark grey tread with black thread guard)					
NA Nylon Antistatic		QD QuickStart (dark grey tread and thread guard)					
ND Nylon Dark Gray		QL QuickStart (light grey tread and thread guard)					
NG Nylon Light Gray		RM Rubber on Metal					
NK Nylon Black		RP Rubber on Plastic					
NS Nylon Plus Stainless		RR Rubber on Rubber					
PA Plastic Antistatic		TP Thermoplastic Rubber					
PD Plastic Dark Gray							
PG Plastic Light Gray							
RZ Razer							
SS Stainless Steel							
ST Solus Tech							
TM Twin-Med							
TW Twin Wheel							
WC Wheel Chair Casters							
WO Misc. Wheel Only							
WW Wheel Chair Wheels							

FORK/RIG NUMBERING SYSTEM

Fork/Rig models are similar to caster models except there is no wheel code. Below is an example of a fork/rig only model for a 5" diameter by 1-1/4" tread width wheel. The fork type is swivel. The fitting type is threaded stem (1/2-13 x 1-1/2").

NG-05-125-SW-TS03

WHEEL NUMBERING SYSTEM

Wheel replacement models are similar to caster models except the last 2 digits. Below example is a wheel for a Nylon Light Grey (NG) caster that has a 5" diameter QuickStart wheel with a dark grey tread, thread guard and Precision Ball Bearing. The tread width is 1-1/4" wide. The axle is 5/16".

NG-05QDP-125-05

04	1/4" axle
05	5/16" axle
06	3/8" axle
08	1/2" axle
10	5/8" axle
12	3/4" axle

DUAL WHEEL (DW) CASTERS

TOP PLATE/
HOLLOW KINGPIN MODELS
FREE SWIVEL • TOTAL LOCK



APPLICATIONS

- Patient Lifts
- Medical Equipment
- Computer Equipment

FEATURES

- Low profile, easy swiveling and smooth rolling.
- Durable zinc plated finish
- Non-marking TPR rubber tread
- Foot activated total lock brake
- Integrated thread guards
- Dual ball bearing raceway
- Precision Bearings in Wheels

Our Dual wheel casters provide a low profile, easy swiveling and smooth rolling.

TOP PLATE SWIVEL MODELS

Wheel Diameter (Inches)	Tread Width (Inches)	Wheel Description	Capacity (Lbs)	Load Height Inches (mm)	Swivel Radius Inches (mm)	Wheel Bearing	Model Number
3	2	Thermoplastic Rubber	220	4-1/16" (103)	2-23/32 (69)	Precision	DW-03TPP-100-SW-TP01



TOP PLATE SWIVEL TOTAL LOCK MODELS (LOCKS WHEEL AND SWIVEL)

Wheel Diameter (Inches)	Tread Width (Inches)	Wheel Description	Capacity (Lbs)	Load Height Inches (mm)	Swivel Radius Inches (mm)	Wheel Bearing	Model Number
3	2	Thermoplastic Rubber	220	4-1/16" (103)	3-1/2 (89)	Precision	DW-03TPP-100-TL-TP01



HOLLOW KINGPIN MODELS

Wheel Diameter (Inches)	Tread Width (Inches)	Wheel Description	Capacity (Lbs)	Load Height Inches (mm)	Swivel Radius Inches (mm)	Wheel Bearing	Model Number
3	2	Thermoplastic Rubber	220	3-15/16" (100)	2-23/32 (69)	Precision	DW-03TPP-100-SW-HK01



HOLLOW KINGPIN TOTAL LOCK MODELS (LOCKS WHEEL AND SWIVEL)

Wheel Diameter (Inches)	Tread Width (Inches)	Wheel Description	Capacity (Lbs)	Load Height Inches (mm)	Swivel Radius Inches (mm)	Wheel Bearing	Model Number
3	2	Thermoplastic Rubber	220	3-15/16" (100)	3-1/2 (89)	Precision	DW-03TPP-100-TL-HK01



TOP PLATE FITTING TP01

Swivel Top Plate Pattern

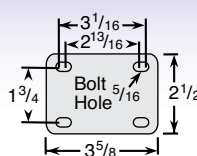

HOLLOW RIVET

Caster is provided assembled. Change HK01 code to HKU1 for unassembled. 1/2" I.D.

TWIN WHEEL (TW) CASTERS

GRIP RING & THREADED STEM MODELS
FREE SWIVEL • BRAKE



APPLICATIONS

- Medical Carts
- Furniture
- Concentrator Bases
- Utility Carts

FEATURES

- Durable Nylon Construction
- Riveted Axle
- Smooth Finish Design
- Custom colors available

Contemporary design features strong nylon construction.

GRIP RING/THREADED STEM MODELS

Wheel Diameter (Inches)	Tread Width (Inches)	Wheel Description	Capacity (Lbs)	Load Height (Inches)	Swivel Radius (Inches)	Wheel Bearing	Model Number
2	1-7/8	Nylon Black	90	2-29/64" (62)	2" (51)	Plain	TW-02NYO-200-SW-
3	2-1/4	Thermoplastic Rubber	165	3-1/4" (83)	2-1/2" (64)	Plain	TW-03TPO-200-SW-
3	2-1/4	Nylon Black	165	3-1/4" (83)	2-1/2" (64)	Plain	TW-03NYO-200-SW-
4	2-3/8	Polyurethane Black	175	4-3/8" (111)	3-5/8" (92)	Plain	TW-04PBO-200-SW-
4	2-3/8	Nylon Black	175	4-3/8" (111)	3-5/8" (92)	Plain	TW-04NYO-200-SW-
5	2-3/8	Polyurethane Black	180	5-7/16" (138)	4-1/2" (114)	Plain	TW-05PBO-200-SW-
5	2-3/8	Nylon Black	180	5-7/16" (138)	4-1/2" (114)	Plain	TW-05NYO-200-SW-



GRIP RING/THREADED STEM BRAKE MODELS

Wheel Diameter (Inches)	Tread Width (Inches)	Wheel Description	Capacity (Lbs)	Load Height (Inches)	Swivel Radius (Inches)	Wheel Bearing	Model Number
3	2-1/4	Thermoplastic Rubber	165	3-1/4" (83)	2-1/2" (64)	Plain	TW-03TPO-200-TB-
3	2-1/4	Nylon Black	165	3-1/4" (83)	2-1/2" (64)	Plain	TW-03NYO-200-TB-
4	2-3/8	Polyurethane Black	175	4-3/8" (111)	3-5/8" (92)	Plain	TW-04PBO-200-TB-
4	2-3/8	Nylon Black	175	4-3/8" (111)	3-5/8" (92)	Plain	TW-04NYO-200-TB-
5	2-3/8	Polyurethane Black	180	5-7/16" (138)	4-1/2" (114)	Plain	TW-05PBO-200-TB-
5	2-3/8	Nylon Black	180	5-7/16" (138)	4-1/2" (114)	Plain	TW-05NYO-200-TB-



Top Plate models are available in some of the above sizes, please consult factory.

Specify Grip Ring Stem (GR) or Threaded Stem (TS) code, see fittings below for dimensions:

GRIP RING STEM FITTINGS

See fittings page for more options.

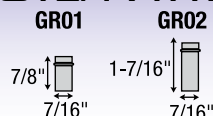

THREADED STEM FITTINGS

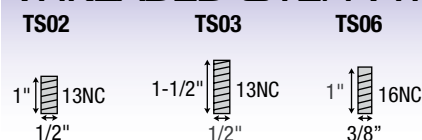

GREY TECH (GT) CASTERS

GRIP RING STEM, THREADED
STEM & SWIVEL PLATE MODELS
FREE SWIVEL • BRAKE



APPLICATIONS

- Electronic Equipment
- Medical Equipment
- Audio/Visual Equipment
- Furniture

FEATURES

- Soft 70-75/A durometer tread constructed of high-tech thermoplastic elastomer
- High load ratings
- Quite mobility
- Riveted axle for positive wheel retention

Soft tread twin wheel caster for quiet mobility

GRIP RING/THREADED STEM MODELS

Wheel Diameter Inches (mm)	Tread Width (Inches)	Wheel Description	Capacity (Lbs)	Load Height Inches (mm)	Swivel Radius Inches (mm)	Wheel Bearing	Model Number
2 (50)	2-1/4	Thermoplastic Rubber	75	2-1/4" (57)	1-13/16" (46)	Plain	GT-02TPO-200-SW-
2-3/8 (60)	2-1/4	Thermoplastic Rubber	100	2-5/8" (67)	2-1/16" (52)	Plain	GT-23TPO-200-SW-
3 (75)	2-1/4	Thermoplastic Rubber	165	3-1/4" (83)	2-1/2" (64)	Plain	GT-03TPO-200-SW-
4 (100)	2-1/4	Thermoplastic Rubber	225	4-3/8" (111)	3-5/8" (92)	Plain	GT-04TPO-200-SW-
5 (125)	2-1/4	Thermoplastic Rubber	225	5-7/16" (138)	4-1/2" (114)	Plain	GT-05TPO-200-SW-

GRIP RING/THREADED STEM BRAKE MODELS

2 (50)	2-1/4	Thermoplastic Rubber	75	2-1/4" (57)	2-3/8" (60)	Plain	GT-02TPO-200-TB-
2-3/8 (60)	2-1/4	Thermoplastic Rubber	100	2-5/8" (67)	2-1/2" (63)	Plain	GT-23TPO-200-TB-
3 (75)	2-1/4	Thermoplastic Rubber	165	3-1/4" (83)	3-3/16" (81)	Plain	GT-03TPO-200-TB-
4 (100)	2-1/4	Thermoplastic Rubber	225	4-3/8" (111)	4-1/2" (114)	Plain	GT-04TPO-200-TB-
5 (125)	2-1/4	Thermoplastic Rubber	225	5-7/16" (138)	5-1/8" (130)	Plain	GT-05TPO-200-TB-

TOP PLATE MODELS

2 (50)	2-1/4	Thermoplastic Rubber	75	2-3/8" (60)	1-13/16" (46)	Plain	GT-02TPO-200-SW-
2-3/8 (60)	2-1/4	Thermoplastic Rubber	100	2-3/4" (70)	2-1/16" (52)	Plain	GT-23TPO-200-SW-
3 (75)	2-1/4	Thermoplastic Rubber	165	3-1/2" (89)	2-1/2" (64)	Plain	GT-03TPO-200-SW-
4 (100)	2-1/4	Thermoplastic Rubber	225	4-5/8" (117)	3-5/8" (92)	Plain	GT-04TPO-200-SW-
5 (125)	2-1/4	Thermoplastic Rubber	225	5-5/8" (143)	4-1/2" (114)	Plain	GT-05TPO-200-SW-

TOP PLATE BRAKE MODELS

2 (50)	2-1/4	Thermoplastic Rubber	75	2-3/8" (60)	2-3/8" (60)	Plain	GT-02TPO-200-TB-
2-3/8 (60)	2-1/4	Thermoplastic Rubber	100	2-3/4" (70)	2-1/2" (63)	Plain	GT-23TPO-200-TB-
3 (75)	2-1/4	Thermoplastic Rubber	165	3-1/2" (89)	3-3/16" (81)	Plain	GT-03TPO-200-TB-
4 (100)	2-1/4	Thermoplastic Rubber	225	4-5/8" (117)	4-1/2" (114)	Plain	GT-04TPO-200-TB-
5 (125)	2-1/4	Thermoplastic Rubber	225	5-5/8" (143)	5-1/8" (130)	Plain	GT-05TPO-200-TB-



Specify fitting code, see fittings below for dimensions:

GRIP RING STEM FITTINGS

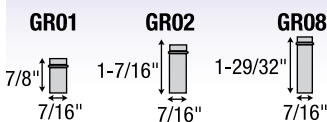

THREADED STEM FITTINGS

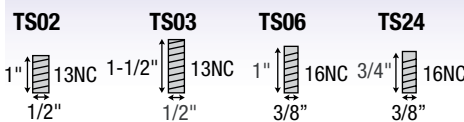

TOP PLATES

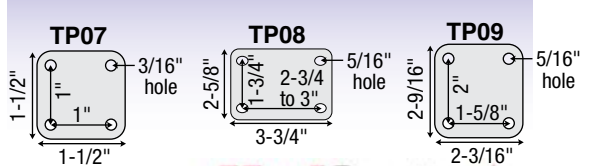

See fittings page for more options.

MEDIMASTER (MM)

THREADED STEM MODELS

FREE SWIVEL • BRAKE



APPLICATIONS

- Nursing Home Beds
- Medical Carts
- Electronic Equipment
- Patient Aids

FEATURES

- Two Precision ball bearings located in the swivel raceway
- Wheels have precision ball bearings for easy rollability
- Our design protects axle/bearing areas from hair/water
- Wheels can be removed for easy cleaning

The MediMaster body and wheel cores are made of Nylon 6 material for added strength and durability. Our wheel treads are made of Thermoplastic polyurethane.



FREE SWIVEL MODELS

Wheel Diameter (Inches)	Tread Width Inches (mm)	Wheel Description	Capacity (Lbs)	Load Height Inches (mm)	Swivel Lead Inches (mm)	Wheel Bearing	Model Number
4	2-13/16" (72)	Polyurethane Gray	220	4-23/32" (120)	3-5/16" (84)	Precision Ball	MM-04PYP-281-SW-_____



BRAKE MODELS

Wheel Diameter (Inches)	Tread Width Inches (mm)	Wheel Description	Capacity (Lbs)	Load Height Inches (mm)	Swivel Lead Inches/mm	Wheel Bearing	Model Number
4	2-13/16" (72)	Polyurethane Gray	220	4-23/32" (120)	3-35/64" (90)	Precision Ball	MM-04PYP-281-TB-_____

THREADED STEM FITTINGS

See fittings page for more options.

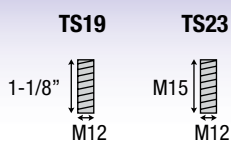

Specify Threaded Stem (TS) code, see fittings below for dimensions:

NON-MAGNETIC (NM)

THREADED STEM AND GRIP RING STEM MODELS FREE SWIVEL

APPLICATIONS

- Medical Equipment
- Hospital Carts
- Electronic Equipment

FEATURES

- Non-magnetic caster is MRI safe
- RoHS compliant
- Soft 70-75/A durometer tread constructed of high-tech thermoplastic elastomer
- High load ratings
- Quiet mobility

Non-magnetic casters are designed for rooms that are subject to highly magnetic forces such as MRI and other scientific equipment.



GRIP RING/THREADED STEM MODELS

Wheel Diameter Inches (mm)	Tread Width (Inches)	Wheel Description	Capacity (Lbs)	Load Height Inches (mm)	Swivel Radius Inches (mm)		
2 (50)	2-1/4	Thermoplastic Rubber	75	2-1/4" (57)	1-13/16" (46)	Plain	NM-02TPO-200-SW-
2-3/8 (60)	2-1/4	Thermoplastic Rubber	100	2-1/2" (63)	2-1/8" (54)	Plain	NM-23TPO-200-SW-
3 (75)	2-1/4	Thermoplastic Rubber	165	3-3/16" (81)	2-1/2" (64)	Plain	NM-03TPO-200-SW-



GRIP RING STEM FITTINGS



THREADED STEM FITTINGS

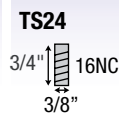

TWIN-MED (TM)

THREADED STEM MODELS

FREE SWIVEL • BRAKE

APPLICATIONS

- Nursing Home Beds
- Medical Carts
- Diagnostic Equipment
- Electronic Equipment
- Patient Aids
- Patient Lifts

FEATURES

- Double ball bearing located in the swivel raceway
- Wheels have easy rollability
- Our design protects axle/bearing areas from hair/water
- Total Lock models lock both the wheel and swivel
- Directional Lock (locks swivel) models are available on the 3" and 4" Models. Please consult factory.

Special colors available. Consult factory.



FREE SWIVEL MODELS

Wheel Diameter (Inches)	Tread Width Inches (mm)	Wheel Description	Capacity (Lbs)	Load Height Inches (mm)	Swivel Lead Inches (mm)	Wheel Bearing	Model Number
3	2-5/16" (59)	Polyurethane Gray	165	3-3/4" (95)	2-5/16" (59)	Plain	TM-03PYO-281-SW-____
4	2-39/64" (66)	Polyurethane Gray	220	5" (127)	3-1/8" (79)	Plain	TM-04PYO-281-SW-____
5	3" (76)	Polyurethane Gray	246	6" (152)	4" (102)	Precision	TM-05PYP-281-SW-____



TOTAL LOCK MODELS (LOCKS WHEEL AND SWIVEL)

Wheel Diameter (Inches)	Tread Width Inches (mm)	Wheel Description	Capacity (Lbs)	Load Height Inches (mm)	Swivel Lead Inches (mm)	Wheel Bearing	Model Number
3	2-5/16" (59)	Polyurethane Gray	165	3-3/4" (95)	2-5/16" (59)	Plain	TM-03PYO-281-TL-____
4	2-39/64" (66)	Polyurethane Gray	220	5" (127)	3-1/2" (89)	Plain	TM-04PYO-281-TL-____
5	3" (76)	Polyurethane Gray	246	6" (152)	4-11/64" (106)	Precision	TM-05PYP-281-TL-____

THREADED STEM FITTINGS

See fittings page for more options.

TS02



TS03



TS18

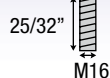

Specify Threaded Stem (TS) code, see fittings below for dimensions:



TWIN-MED (TM)

TOP PLATE MODELS
FREE SWIVEL • BRAKE



APPLICATIONS

- Nursing Home Beds
- Medical Carts
- Diagnostic Equipment
- Electronic Equipment
- Patient Aids
- Patient Lifts

FEATURES

- Double ball bearing located in the swivel raceway
- Wheels have easy rollability
- Our design protects axle/bearing areas from hair/water
- Total Lock models lock both the wheel and swivel
- Directional Lock (locks swivel) models are available on the 3" and 4" Models. Please consult factory.

Special colors available.
Consult factory.



FREE SWIVEL MODELS

Wheel Diameter (Inches)	Tread Width Inches (mm)	Wheel Description	Capacity (Lbs)	Load Height Inches (mm)	Swivel Radius Inches (mm)	Wheel Bearing	Model Number
3	2-5/16 (59)	Polyurethane Gray	165	4-1/8" (105)	2-5/16" (59)	Plain	TM-03PYO-281-SW-TP01
4	2-39/64" (66)	Polyurethane Gray	220	5-3/8" (137)	3-1/8" (79)	Plain	TM-04PYO-281-SW-TP01
5	3" (76)	Polyurethane Gray	246	6-3/8" (162)	4" (102)	Precision	TM-05PYP-281-SW-TP01



TOTAL LOCK MODELS (LOCKS WHEEL AND SWIVEL)

Wheel Diameter (Inches)	Tread Width Inches (mm)	Wheel Description	Capacity (Lbs)	Load Height Inches (mm)	Swivel Lead Inches (mm)	Wheel Bearing	Model Number
3	2-5/16 (59)	Polyurethane Gray	165	4-1/8" (105)	2-5/16" (59)	Plain	TM-03PYO-281-TL-TP01
4	2-39/64" (66)	Polyurethane Gray	220	5-3/8" (137)	3-1/2" (89)	Plain	TM-04PYO-281-TL-TP01
5	3" (76)	Polyurethane Gray	246	6-3/8" (162)	4-11/64" (106)	Precision	TM-05PYP-281-TL-TP01

TOP PLATE FITTINGS

See fittings page for more options.

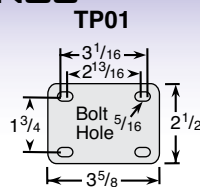

KICK STOP (KS)

FREE SWIVEL • TOTAL LOCK • DIRECTION LOCK



- APPLICATIONS**
- Medical and diagnostic equipment
 - Computer equipment
 - Electronic equipment
 - High-tech products

- FEATURES**
- Foot brake easily engaged; mechanically locks both swivel and wheel rotation
 - Strong pressure diecast metal construction for lasting performance and maximum reliability
 - Precision axle built to exacting tolerances for smooth operation and extended service life
 - Aluminum die cast body and wheel centers
 - Standard finish is white or ball burnished and lacquered

Medcaster Kick Stop casters give you the benefits of twin-wheel design with the convenience of a foot brake to lock both wheel and swivel simultaneously. This modern design features two wheels that spin independently of each other for easier turning in tight spots and for improved stability. Custom colors are available to match your equipment (Consult factory). Kick Stop casters are covered by world-wide patents and designs.

FREE SWIVEL MODELS

Wheel Diameter (Inches)	Tread Width (Inches)	Wheel Description	Capacity (lbs)	Load Height Inches (mm)	Swivel Lead (Inches/mm)	Wheel Bearing	Model Number
3	19/32	Polyurethane Gray	132	3-37/64" (91)	7/8" (22)	Delrin	KS-03PYD-150-SW-____
3	19/32	Polyurethane Black	132	3-37/64" (91)	7/8" (22)	Delrin	KS-03PBD-150-SW-____
4	19/32	Anti-Static Black Rubber	132	4-3/4" (120)	1-9/64" (29)	Roller	KS-04ARR-150-SW-____
4	19/32	Rubber Gray	132	4-3/4" (120)	1-9/64" (29)	Roller	KS-04RPR-150-SW-____
4	19/32	Rubber Gray	132	4-3/4" (120)	1-9/64" (29)	Delrin	KS-04RPD-150-SW-____
5	5/8	Anti-Static Black Rubber	175	5-13/16" (148)	1-35/64" (39)	Roller	KS-05ARR-150-SW-____
5	5/8	Rubber Gray	175	5-13/16" (148)	1-35/64" (39)	Roller	KS-05RPR-150-SW-____
5	5/8	Rubber Gray	175	5-13/16" (148)	1-35/64" (39)	Delrin	KS-05RPD-150-SW-____

TOTAL LOCK MODELS

3	19/32	Polyurethane Gray	132	3-37/64" (91)	7/8" (22)	Delrin	KS-03PYD-150-TL-____
3	19/32	Polyurethane Black	132	3-37/64" (91)	7/8" (22)	Delrin	KS-03PBD-150-TL-____
4	19/32	Anti-Static Black Rubber	132	4-3/4" (120)	1-9/64" (29)	Roller	KS-04ARR-150-TL-____
4	19/32	Rubber Gray	132	4-3/4" (120)	1-9/64" (29)	Roller	KS-04RPR-150-TL-____
4	19/32	Rubber Gray	132	4-3/4" (120)	1-9/64" (29)	Delrin	KS-04RPD-150-TL-____
5	5/8	Anti-Static Black Rubber	175	5-13/16" (148)	1-35/64" (39)	Roller	KS-05ARR-150-TL-____
5	5/8	Rubber Gray	175	5-13/16" (148)	1-35/64" (39)	Roller	KS-05RPR-150-TL-____
5	5/8	Rubber Gray	175	5-13/16" (148)	1-35/64" (39)	Delrin	KS-05RPD-150-TL-____

THREADED STEM FITTINGS

See fittings page for more options.

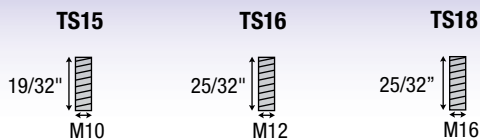

Specify Threaded Stem (TS) code, see fittings below for dimensions:

NEOTEQ DUAL (DN) COMFORT ROLL

TOP PLATE MODELS
FREE SWIVEL • BRAKE



- APPLICATIONS**
- Laboratory Equipment
 - IV Stands
 - Mobile Computer Stands
 - Medical Equipment

- FEATURES**
- Bright Chrome Finish
 - Dual wheels maneuver easily
 - Matching Chrome Thread Guards for wheels
 - Non-Marking Soft-Neoprene Rubber wheels
 - Dual Ball Swivel Raceways for added strength
 - Precision ball bearings in wheels for easier rollability
 - Upper dustcap to prevent dirt and dust build-up

Dual Wheel Chrome NeoTeq series are designed to provide your equipment with a smooth and quiet roll with easy turning and maneuverability.

SWIVEL TOP PLATE MODELS



Wheel Diameter (Inches)	Tread Width Inches (mjm)	Wheel Description	Capacity (Lbs)	Load Height Inches (mm)	Swivel Radius Inches (mm)	Wheel Bearing	Model Number
2	1" (25)	Neoprene Rubber	250	3-3/8" (86)	2-3/8 (60)	Precision Ball	DN-02NRP-100-SW-TP01
2-1/2	1" (25)	Neoprene Rubber	300	3-7/8 (98)	2-1/2" (63)	Precision Ball	DN-25NRP-100-SW-TP01

Rigid models available.
Consult factory

FITTINGS TP01

See fittings page for more options.

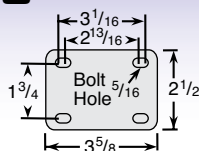

NEOTEQ (CN) COMFORT ROLL

SWIVEL/GRIP RING/THREADED/
HOLLOW KINGPIN

FREE SWIVEL • TOTAL LOCK



APPLICATIONS

- Laboratory Equipment
- IV Stands
- Mobile Computer Stands
- Medical Equipment

FEATURES

- Bright Chrome Finish
- Matching Chrome Thread Guards for wheels
- Non-Marking Soft-Neoprene Rubber wheels
- Dual Ball Swivel Raceways for added strength
- Total Lock Brake models lock both swivel and wheel
- Precision ball bearings in wheels for easier rollability
- Upper raceway seal to prevent dirt and dust build-up

Our Chrome NeoTeq series are designed to provide your equipment with a smooth and quiet roll.

SWIVEL TOP PLATE MODELS

Wheel Diameter (Inches)	Tread Width (Inches)	Wheel Description	Capacity (Lbs)	Load Height Inches (mm)	Swivel Radius Inches (mm)	Wheel Bearing	Model Number
2	1	Neoprene Rubber	125	2-15/16" (75)	2" (51)	Precision Ball	CN-02NRP-100-SW-TP02
3	1	Neoprene Rubber	175	4-5/32" (105)	2-13/16" (71)	Precision Ball	CN-03NRP-100-SW-TP02



SWIVEL PLATE TOTAL LOCK MODELS

(LOCKS WHEEL AND SWIVEL)

Wheel Diameter (Inches)	Tread Width (Inches)	Wheel Description	Capacity (Lbs)	Load Height Inches (mm)	Swivel Radius Inches (mm)	Wheel Bearing	Model Number
2	1	Neoprene Rubber	125	2-15/16" (75)	2" (51)	Precision Ball	CN-02NRP-100-TL-TP02
3	1	Neoprene Rubber	175	4-5/32" (105)	2-13/16" (71)	Precision Ball	CN-03NRP-100-TL-TP02



FITTINGS

Swivel Top Plate Fitting Pattern

2" diameter caster: 13/16" x 1-1/4" through 1-7/8" slotted

3" diameter caster: 13/16" x 1-7/8"

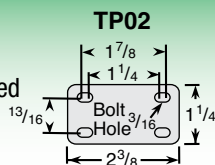

NEOTEQ (CN) COMFORT ROLL

GRIP RING STEM MODELS

Wheel Diameter (Inches)	Tread Width (Inches)	Wheel Description	Capacity (Lbs)	Load Height Inches (mm)	Swivel Radius Inches (mm)	Wheel Bearing	Model Number
2	1	Neoprene Rubber	125	2-11/16" (68)	2" (51)	Precision Ball	CN-02NRP-100-SW-GR01
3	1	Neoprene Rubber	175	4" (102)	2-13/16" (71)	Precision Ball	CN-03NRP-100-SW-GR01

GRIP RING STEM TOTAL LOCK MODELS

(LOCKS WHEEL AND SWIVEL)

2	1	Neoprene Rubber	125	2-11/16" (68)	2" (51)	Precision Ball	CN-02NRP-100-TL-GR01
3	1	Neoprene Rubber	175	4" (102)	2-13/16" (71)	Precision Ball	CN-03NRP-100-TL-GR01

THREADED STEM MODELS

Wheel Diameter (Inches)	Tread Width (Inches)	Wheel Description	Capacity (Lbs)	Load Height Inches (mm)	Swivel Radius Inches (mm)	Wheel Bearing	Model Number
3	1	Neoprene Rubber	175	4" (102)	2-13/16" (71)	Precision Ball	CN-03NRP-100-SW-TS06

THREADED STEM TOTAL LOCK MODELS

(LOCKS WHEEL AND SWIVEL)

3	1	Neoprene Rubber	175	4" (102)	2-13/16" (71)	Precision Ball	CN-03NRP-100-TL-TS06
---	---	-----------------	-----	----------	---------------	----------------	----------------------

HOLLOW KINGPIN MODELS

Wheel Diameter (Inches)	Tread Width (Inches)	Wheel Description	Capacity (Lbs)	Load Height Inches (mm)	Swivel Radius Inches (mm)	Wheel Bearing	Model Number
2	1	Neoprene Rubber	125	2-11/16" (68)	2" (51)	Precision Ball	CN-02NRP-100-SW-HK04
3	1	Neoprene Rubber	175	4" (102)	2-13/16" (71)	Precision Ball	CN-03NRP-100-SW-HK04

Recommended for use with 3/8" diameter fittings.

HOLLOW KINGPIN TOTAL LOCK MODELS

(LOCKS WHEEL AND SWIVEL)

2	1	Neoprene Rubber	125	2-11/16" (68)	2" (51)	Precision Ball	CN-02NRP-100-TL-HK04
3	1	Neoprene Rubber	175	4" (102)	2-13/16" (71)	Precision Ball	CN-03NRP-100-TL-HK04

Recommended for use with 3/8" diameter fittings.

GRIP RING STEM

GR01



See fitting chart for additional options.

THREADED STEM

TS06



HOLLOW RIVET

Recommended for use with 3/8" diameter fittings.



RAZER (RZ)

TOP PLATE MODELS

FREE SWIVEL • TOTAL LOCK



APPLICATIONS

- Laundry Hampers
- Mobile Hospital Furniture
- Bassinets
- Hospital
- Chairs/ Recliners
- Home Healthcare Beds

FEATURES

- Economical
- Polished zinc finish
- Double ball swivel raceways for added strength
- Total Lock Brake models lock both swivel and wheel
- Full thread guards for added protection (except 2" diameter models)
- Ball bearings included on 3" to 5" wheel diameter models. Plain bearing on 2" model

Polyurethane wheels also available, contact MedCaster.

SWIVEL TOP PLATE MODELS

Wheel Diameter (Inches)	Tread Width (Inches)	Wheel Description	Capacity (Lbs)	Load Height Inches (mm)	Swivel Radius Inches (mm)	Wheel Bearing	Model Number
2	3/4"	Grey TPR	110	2-13/16" (71)	1.95" (50)	Plain	RZ-02TPN-070-SW-TP06
3	7/8"	Grey TPR	140	4.07" (103)	2.85" (73)	Ball	RZ-03TPP-090-SW-TP05
4	7/8"	Grey TPR	160	4.92" (125)	3.35" (85)	Ball	RZ-04TPP-090-SW-TP05
5	7/8"	Grey TPR	165	6.04" (153)	3.84" (98)	Ball	RZ-05TPP-090-SW-TP05



SWIVEL TOP PLATE TOTAL LOCK MODELS

(LOCKS WHEEL AND SWIVEL)

Wheel Diameter (Inches)	Tread Width (Inches)	Wheel Description	Capacity (Lbs)	Load Height Inches (mm)	Swivel Radius Inches (mm)	Wheel Bearing	Model Number
2	3/4"	Grey TPR	110	2-13/16" (71)	3.23" (82)	Plain	RZ-02TPN-070-TL-TP06
3	7/8"	Grey TPR	140	4.07" (103)	3.90" (104)	Ball	RZ-03TPP-090-TL-TP05
4	7/8"	Grey TPR	160	4.92" (125)	4.19" (107)	Ball	RZ-04TPP-090-TL-TP05
5	7/8"	Grey TPR	165	6.04" (153)	4.19" (107)	Ball	RZ-05TPP-090-TL-TP05



TOP PLATE FITTING

Swivel Top Plate Pattern

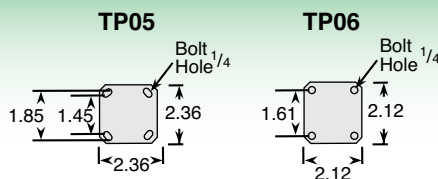

RAZER (RZ)

HOLLOW KINGPIN MODELS

FREE SWIVEL • TOTAL LOCK



APPLICATIONS

- Laundry Hampers
- Mobile Hospital Furniture
- Bassinets
- Hospital
- Chairs/ Recliners
- Home Healthcare Beds

FEATURES

- Economical
- Polished zinc finish
- Double ball swivel raceways for added strength
- Total Lock Brake models lock both swivel and wheel
- Full thread guards for added protection (except 2" diameter models)
- Ball bearings included on 3" to 5" wheel diameter models. Plain bearing on 2" model

Polyurethane wheels also available, contact MedCaster.

HOLLOW KINGPIN MODELS

Wheel Diameter (Inches)	Tread Width (Inches)	Wheel Description	Capacity (Lbs)	Load Height Inches (mm)	Swivel Radius Inches (mm)	Wheel Bearing	Model Number
2	3/4"	Grey TPR	110	2.75" (70)	1.95" (50)	Plain	RZ-02TPN-070-SW-HK04
3	7/8"	Grey TPR	140	3.98" (101)	2.85" (73)	Ball	RZ-03TPP-090-SW-HK04
4	7/8"	Grey TPR	160	4.84" (123)	3.35" (85)	Ball	RZ-04TPP-090-SW-HK04
5	7/8"	Grey TPR	165	5.95" (151)	3.84" (98)	Ball	RZ-05TPP-090-SW-HK04



HOLLOW KINGPIN TOTAL LOCK MODELS

(LOCKS WHEEL AND SWIVEL)

Wheel Diameter (Inches)	Tread Width (Inches)	Wheel Description	Capacity (Lbs)	Load Height Inches (mm)	Swivel Radius Inches (mm)	Wheel Bearing	Model Number
2	3/4"	Grey TPR	110	2.75" (70)	3.23" (82)	Plain	RZ-02TPN-070-TL-HK04
3	7/8"	Grey TPR	140	3.98" (101)	3.90" (104)	Ball	RZ-03TPP-090-TL-HK04
4	7/8"	Grey TPR	160	4.84" (123)	4.19" (107)	Ball	RZ-04TPP-090-TL-HK04
5	7/8"	Grey TPR	165	5.95" (151)	4.19" (107)	Ball	RZ-05TPP-090-TL-HK04



HOLLOW RIVET

Recommended for use with 3/8" diameter fittings.

RAZER (RZ)

GRIP RING STEM MODELS

FREE SWIVEL • TOTAL LOCK



APPLICATIONS

- Laundry Hampers
- Mobile Hospital Furniture
- Bassinets
- Hospital
- Chairs/ Recliners
- Home Healthcare Beds

FEATURES

- Economical
- Polished zinc finish
- Double ball swivel raceways for added strength
- Total Lock Brake models lock both swivel and wheel
- Full thread guards for added protection (except 2" diameter models)
- Ball bearings included on 3" to 5" wheel diameter models. Plain bearing on 2" model

Polyurethane wheels also available, contact MedCaster.

GRIP RING STEM MODELS

Wheel Diameter (Inches)	Tread Width (Inches)	Wheel Description	Capacity (Lbs)	Load Height Inches (mm)	Swivel Radius Inches (mm)	Wheel Bearing	Model Number
2	3/4"	Grey TPR	110	2.75" (70)	1.95" (50)	Plain	RZ-02TPN-070-SW-_____
3	7/8"	Grey TPR	140	3.98" (101)	2.85" (73)	Ball	RZ-03TPP-090-SW-_____
4	7/8"	Grey TPR	160	4.84" (123)	3.35" (85)	Ball	RZ-04TPP-090-SW-_____
5	7/8"	Grey TPR	165	5.95" (151)	3.84" (98)	Ball	RZ-05TPP-090-SW-_____



GRIP RING STEM TOTAL LOCK MODELS

(LOCKS WHEEL AND SWIVEL)

Wheel Diameter (Inches)	Tread Width (Inches)	Wheel Description	Capacity (Lbs)	Load Height Inches (mm)	Swivel Radius Inches (mm)	Wheel Bearing	Model Number
2	3/4"	Grey TPR	110	2.75" (70)	3.23" (82)	Plain	RZ-02TPN-070-TL-_____
3	7/8"	Grey TPR	140	3.98" (101)	3.90" (104)	Ball	RZ-03TPP-090-TL-_____
4	7/8"	Grey TPR	160	4.84" (123)	4.19" (107)	Ball	RZ-04TPP-090-TL-_____
5	7/8"	Grey TPR	165	5.95" (151)	4.19" (107)	Ball	RZ-05TPP-090-TL-_____



Specify Grip Ring Stem (GR) code, see fittings at left for dimensions.

GRIP RING STEM FITTINGS

See fittings page for more options.



RAZER (RZ)

THREADED STEM MODELS FREE SWIVEL • TOTAL LOCK



APPLICATIONS

- Laundry Hampers
- Mobile Hospital Furniture
- Bassinets
- Hospital
- Chairs/ Recliners
- Home Healthcare Beds

FEATURES

- Economical
- Polished zinc finish
- Double ball swivel raceways for added strength
- Total Lock Brake models lock both swivel and wheel
- Full thread guards for added protection (except 2" diameter models)
- Ball bearings included on 3" to 5" wheel diameter models. Plain bearing on 2" model

Polyurethane wheels also available, contact MedCaster.

THREADED STEM MODELS

Wheel Diameter (Inches)	Tread Width (Inches)	Wheel Description	Capacity (Lbs)	Load Height Inches (mm)	Swivel Radius Inches (mm)	Wheel Bearing	Model Number
2	3/4"	Grey TPR	110	2.75" (70)	1.95" (50)	Plain	RZ-02TPN-070-SW-_____
3	7/8"	Grey TPR	140	3.98" (101)	2.85" (73)	Ball	RZ-03TPP-090-SW-_____
4	7/8"	Grey TPR	160	4.84" (123)	3.35" (85)	Ball	RZ-04TPP-090-SW-_____
5	7/8"	Grey TPR	165	5.95" (151)	3.84" (98)	Ball	RZ-05TPP-090-SW-_____



THREADED STEM TOTAL LOCK MODELS (LOCKS WHEEL AND SWIVEL)

Wheel Diameter (Inches)	Tread Width (Inches)	Wheel Description	Capacity (Lbs)	Load Height Inches (mm)	Swivel Radius Inches (mm)	Wheel Bearing	Model Number
2	3/4"	Grey TPR	110	2.75" (70)	3.23" (82)	Plain	RZ-02TPN-070-TL-_____
3	7/8"	Grey TPR	140	3.98" (101)	3.90" (104)	Ball	RZ-03TPP-090-TL-_____
4	7/8"	Grey TPR	160	4.84" (123)	4.19" (107)	Ball	RZ-04TPP-090-TL-_____
5	7/8"	Grey TPR	165	5.95" (151)	4.19" (107)	Ball	RZ-05TPP-090-TL-_____



Specify Threaded Stem (TS) code, see fittings at left for dimensions:

THREADED STEM FITTINGS

See fittings page for more options.

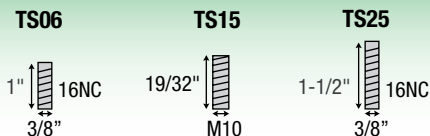

CHROME HOSPITAL (CH)

TOP PLATE MODELS

FREE SWIVEL • TOTAL LOCK • DIRECTION LOCK



APPLICATIONS

- Food Service
- Case Carts
- Utility Carts
- Hospital Equipment
- Institutional Equipment
- Store Fixtures
- Medical equipment

New larger brake pedal for easy braking action

FEATURES

- Chrome Plated Finish
- Dual Ball Swivel Raceways for added strength
- Total Lock Brake models lock both swivel and wheel
- Directional lock models lock swivel only (helps with steering)
- Precision ball bearings in wheels for easier rollability
- Wheels have full thread guards for added protection

The CH series brings you Chrome Hospital casters at an affordable price.

SWIVEL TOP PLATE MODELS

Wheel Diameter (Inches)	Tread Width (Inches)	Wheel Description	Capacity (Lbs)	Load Height Inches (mm)	Swivel Radius Inches (mm)	Wheel Bearing	Model Number
3	1-1/4	Conductive Rubber	165	4-7/16" (113)	2-29/32" (74)	Annular Ball	CH-03CRB-125-SW-___
3	1-1/4	Thermoplastic Rubber	165	4-7/16" (113)	2-29/32" (74)	Precision Ball	CH-03TPP-125-SW-___
3	1-1/4	Anti-Microbial TPR	165	4-7/16" (113)	2-29/32" (74)	Precision Ball	CH-03AMP-125-SW-___
3	1-1/4	Polyurethane TPU	165	4-7/16" (113)	2-29/32" (74)	Precision Ball	CH-03PYP-125-SW-___
4	1-1/4	Conductive Rubber	190	5-7/16" (138)	3-37/64" (91)	Annular Ball	CH-04CRB-125-SW-___
4	1-1/4	Thermoplastic Rubber	190	5-7/16" (138)	3-37/64" (91)	Precision Ball	CH-04TPP-125-SW-___
4	1-1/4	Anti-Microbial TPR	190	5-7/16" (138)	3-37/64" (91)	Precision Ball	CH-04AMP-125-SW-___
4	1-1/4	Polyurethane TPU	190	5-7/16" (138)	3-37/64" (91)	Precision Ball	CH-04PYP-125-SW-___
5	1-1/4	Conductive Rubber	220	6-7/16" (163)	4-7/32" (108)	Annular Ball	CH-05CRB-125-SW-___
5	1-1/4	Thermoplastic Rubber	220	6-7/16" (163)	4-7/32" (108)	Precision Ball	CH-05TPP-125-SW-___
5	1-1/4	Anti-Microbial TPR	220	6-7/16" (163)	4-7/32" (108)	Precision Ball	CH-05AMP-125-SW-___
5	1-1/4	Polyurethane TPU	220	6-7/16" (163)	4-7/32" (108)	Precision Ball	CH-05PYP-125-SW-___
6	1-1/4	Conductive Rubber	240	7-13/32" (188)	4-39/64 (117)	Annular Ball	CH-06CRB-125-SW-___
6	1-1/4	Thermoplastic Rubber	240	7-13/32" (188)	4-39/64 (117)	Precision Ball	CH-06TPP-125-SW-___
6	1-1/4	Anti-Microbial TPR	240	7-13/32" (188)	4-39/64 (117)	Precision Ball	CH-06AMP-125-SW-___
6	1-1/4	Polyurethane TPU	240	7-13/32" (188)	4-39/64 (117)	Precision Ball	CH-06PYP-125-SW-___



Anti-Microbial wheels have light green tread.



Rigid Models available change "SW to "RG"

Specify Top Plate (TP) code, see fittings at left for dimensions.

TOP PLATE FITTING

Swivel Top Plate Pattern

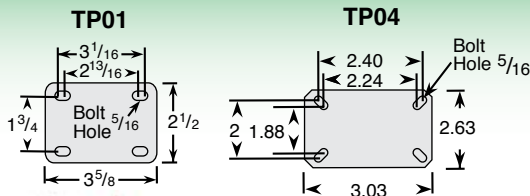

CHROME HOSPITAL (CH)

SWIVEL TOP PLATE TOTAL LOCK MODELS (LOCKS WHEEL AND SWIVEL)

Wheel Diameter (Inches)	Tread Width (Inches)	Wheel Description	Capacity (Lbs)	Load Height Inches (mm)	Swivel Radius Inches (mm)	Wheel Bearing	Model Number
3	1-1/4	Conductive Rubber	165	4-7/16" (113)	4-1/4" (108)	Annular Ball	CH-03CRB-125-TL-___
3	1-1/4	Thermoplastic Rubber	165	4-7/16" (113)	4-1/4" (108)	Precision Ball	CH-03TPP-125-TL-___
3	1-1/4	Anti-Microbial TPR	165	4-7/16" (113)	4-1/4" (108)	Precision Ball	CH-03AMP-125-TL-___
3	1-1/4	Polyurethane TPU	165	4-7/16" (113)	4-1/4" (108)	Precision Ball	CH-03PYP-125-TL-___
4	1-1/4	Conductive Rubber	190	5-7/16" (138)	4-35/64" (115)	Annular Ball	CH-04CRB-125-TL-___
4	1-1/4	Thermoplastic Rubber	190	5-7/16" (138)	4-35/64" (115)	Precision Ball	CH-04TPP-125-TL-___
4	1-1/4	Anti-Microbial TPR	190	5-7/16" (138)	4-35/64" (115)	Precision Ball	CH-04AMP-125-TL-___
4	1-1/4	Polyurethane TPU	190	5-7/16" (138)	4-35/64" (115)	Precision Ball	CH-04PYP-125-TL-___
5	1-1/4	Conductive Rubber	220	6-7/16" (163)	4-55/64" (123)	Annular Ball	CH-05CRB-125-TL-___
5	1-1/4	Thermoplastic Rubber	220	6-7/16" (163)	4-55/64" (123)	Precision Ball	CH-05TPP-125-TL-___
5	1-1/4	Anti-Microbial TPR	220	6-7/16" (163)	4-55/64" (123)	Precision Ball	CH-05AMP-125-TL-___
5	1-1/4	Polyurethane TPU	220	6-7/16" (163)	4-55/64" (123)	Precision Ball	CH-05PYP-125-TL-___
6	1-1/4	Conductive Rubber	240	7-13/32" (188)	4-55/64" (123)	Annular Ball	CH-06CRB-125-TL-___
6	1-1/4	Thermoplastic Rubber	240	7-13/32" (188)	4-55/64" (123)	Precision Ball	CH-06TPP-125-TL-___
6	1-1/4	Anti-Microbial TPR	240	7-13/32" (188)	4-55/64" (123)	Precision Ball	CH-06AMP-125-TL-___
6	1-1/4	Polyurethane TPU	240	7-13/32" (188)	4-55/64" (123)	Precision Ball	CH-06PYP-125-TL-___



Total Lock
Change "SW" to "TL". **Red** sticker on pedal.

SWIVEL TOP PLATE DIRECTION LOCK MODELS (LOCKS SWIVEL ONLY)

Wheel Diameter (Inches)	Tread Width (Inches)	Wheel Description	Capacity (Lbs)	Load Height Inches (mm)	Swivel Radius Inches (mm)	Wheel Bearing	Model Number
3	1-1/4	Conductive Rubber	165	4-7/16" (113)	4-1/4" (108)	Annular Ball	CH-03CRB-125-DL-___
3	1-1/4	Thermoplastic Rubber	165	4-7/16" (113)	4-1/4" (108)	Precision Ball	CH-03TPP-125-DL-___
3	1-1/4	Anti-Microbial TPR	165	4-7/16" (113)	4-1/4" (108)	Precision Ball	CH-03AMP-125-DL-___
3	1-1/4	Polyurethane TPU	165	4-7/16" (113)	4-1/4" (108)	Precision Ball	CH-03PYP-125-DL-___
4	1-1/4	Conductive Rubber	190	5-7/16" (138)	4-35/64" (115)	Annular Ball	CH-04CRB-125-DL-___
4	1-1/4	Thermoplastic Rubber	190	5-7/16" (138)	4-35/64" (115)	Precision Ball	CH-04TPP-125-DL-___
4	1-1/4	Anti-Microbial TPR	190	5-7/16" (138)	4-35/64" (115)	Precision Ball	CH-04AMP-125-DL-___
4	1-1/4	Polyurethane TPU	190	5-7/16" (138)	4-35/64" (115)	Precision Ball	CH-04PYP-125-DL-___
5	1-1/4	Conductive Rubber	220	6-7/16" (163)	4-55/64" (123)	Annular Ball	CH-05CRB-125-DL-___
5	1-1/4	Thermoplastic Rubber	220	6-7/16" (163)	4-55/64" (123)	Precision Ball	CH-05TPP-125-DL-___
5	1-1/4	Anti-Microbial TPR	220	6-7/16" (163)	4-55/64" (123)	Precision Ball	CH-05AMP-125-DL-___
5	1-1/4	Polyurethane TPU	220	6-7/16" (163)	4-55/64" (123)	Precision Ball	CH-05PYP-125-DL-___
6	1-1/4	Conductive Rubber	240	7-13/32" (188)	4-55/64" (123)	Annular Ball	CH-06CRB-125-DL-___
6	1-1/4	Thermoplastic Rubber	240	7-13/32" (188)	4-55/64" (123)	Precision Ball	CH-06TPP-125-DL-___
6	1-1/4	Anti-Microbial TPR	240	7-13/32" (188)	4-55/64" (123)	Precision Ball	CH-06AMP-125-DL-___
6	1-1/4	Polyurethane TPU	240	7-13/32" (188)	4-55/64" (123)	Precision Ball	CH-06PYP-125-DL-___



Direction Lock
Change "SW" to "DL". **Green** sticker on pedal.

TOP PLATE FITTING

Swivel Top Plate Pattern

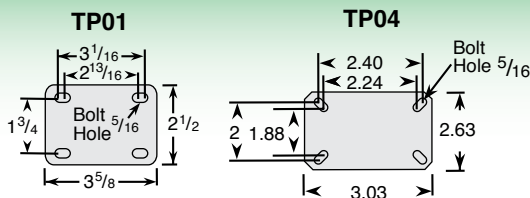

Specify Top Plate (TP) code, see fittings at left for dimensions.

CHROME HOSPITAL (CH)

HOLLOW KINGPIN MODELS

FREE SWIVEL • TOTAL LOCK • DIRECTION LOCK



APPLICATIONS

- Food Service
- Case Carts
- Utility Carts
- Hospital Equipment
- Institutional Equipment
- Store Fixtures
- Medical equipment

New larger brake pedal for easy braking action

FEATURES

- Chrome Plated Finish
- Dual Ball Swivel Raceways for added strength
- Total Lock Brake models lock both swivel and wheel
- Directional lock models lock swivel only (helps with steering)
- Precision ball bearings in wheels for easier rollability
- Wheels have full thread guards for added protection

The CH series brings you Chrome Hospital casters at an affordable price.

HOLLOW KINGPIN MODELS

Wheel Diameter (Inches)	Tread Width (Inches)	Wheel Description	Capacity (Lbs)	Load Height Inches (mm)	Swivel Radius Inches (mm)	Wheel Bearing	Model Number
3	1-1/4	Conductive Rubber	165	4-5/16" (109)	2-29/32" (74)	Annular Ball	CH-03CRB-125-SW-HKU1
3	1-1/4	Thermoplastic Rubber	165	4-5/16" (109)	2-29/32" (74)	Precision Ball	CH-03TPP-125-SW-HKU1
3	1-1/4	Anti-Microbial TPR	165	4-5/16" (109)	2-29/32" (74)	Precision Ball	CH-03AMP-125-SW-HKU1
3	1-1/4	Polyurethane TPU	165	4-5/16" (109)	2-29/32" (74)	Precision Ball	CH-03PYP-125-SW-HKU1
4	1-1/4	Conductive Rubber	165	5-5/16" (135)	3-37/64" (91)	Annular Ball	CH-04CRB-125-SW-HKU1
4	1-1/4	Thermoplastic Rubber	190	5-5/16" (135)	3-37/64" (91)	Precision Ball	CH-04TPP-125-SW-HKU1
4	1-1/4	Anti-Microbial TPR	190	5-5/16" (135)	3-37/64" (91)	Precision Ball	CH-04AMP-125-SW-HKU1
4	1-1/4	Polyurethane TPU	190	5-5/16" (135)	3-37/64" (91)	Precision Ball	CH-04PYP-125-SW-HKU1
5	1-1/4	Conductive Rubber	220	6-5/16" (160)	4-7/32" (108)	Annular Ball	CH-05CRB-125-SW-HKU1
5	1-1/4	Thermoplastic Rubber	220	6-5/16" (160)	4-7/32" (108)	Precision Ball	CH-05TPP-125-SW-HKU1
5	1-1/4	Anti-Microbial TPR	220	6-5/16" (160)	4-7/32" (108)	Precision Ball	CH-05AMP-125-SW-HKU1
5	1-1/4	Polyurethane TPU	220	6-5/16" (160)	4-7/32" (108)	Precision Ball	CH-05PYP-125-SW-HKU1
6	1-1/4	Conductive Rubber	240	7-9/32" (185)	4-39/64 (117)	Annular Ball	CH-06CRB-125-SW-HKU1
6	1-1/4	Thermoplastic Rubber	240	7-9/32" (185)	4-39/64 (117)	Precision Ball	CH-06TPP-125-SW-HKU1
6	1-1/4	Anti-Microbial TPR	240	7-9/32" (185)	4-39/64 (117)	Precision Ball	CH-06AMP-125-SW-HKU1
6	1-1/4	Polyurethane TPU	240	7-9/32" (185)	4-39/64 (117)	Precision Ball	CH-06PYP-125-SW-HKU1



Anti-Microbial wheels have light green tread.



HOLLOW KINGPIN

Caster is provided unassembled to make it easy to add your choice of fitting. If you would like these assembled change HKU1 to HK01. 1/2 I.D.

HOLLOW KINGPIN

Caster is provided unassembled to make it easy to add your choice of fitting. If you would like these assembled change HKU1 to HK01. 1/2 I.D.

CHROME HOSPITAL (CH)

HOLLOW KINGPIN MODELS

FREE SWIVEL • TOTAL LOCK • DIRECTION LOCK

Wheel Diameter (Inches)	Tread Width (Inches)	Wheel Description	Capacity (Lbs)	Load Height Inches (mm)	Swivel Radius Inches (mm)	Wheel Bearing	Model Number
3	1-1/4	Conductive Rubber	165	4-5/16" (109)	4-1/4" (108)	Precision Ball	CH-03CRB-125-TL-HKU1
3	1-1/4	Thermoplastic Rubber	165	4-5/16" (109)	4-1/4" (108)	Precision Ball	CH-03TPP-125-TL-HKU1
3	1-1/4	Anti-Microbial TPR	165	4-5/16" (109)	4-1/4" (108)	Precision Ball	CH-03AMP-125-TL-HKU1
3	1-1/4	Polyurethane TPU	165	4-5/16" (109)	4-1/4" (108)	Precision Ball	CH-03PYP-125-TL-HKU1
4	1-1/4	Conductive Rubber	190	5-5/16" (135)	4-35/64" (115)	Precision Ball	CH-04CRB-125-TL-HKU1
4	1-1/4	Thermoplastic Rubber	190	5-5/16" (135)	4-35/64" (115)	Precision Ball	CH-04TPP-125-TL-HKU1
4	1-1/4	Anti-Microbial TPR	190	5-5/16" (135)	4-35/64" (115)	Precision Ball	CH-04AMP-125-TL-HKU1
4	1-1/4	Polyurethane TPU	190	5-5/16" (135)	4-35/64" (115)	Precision Ball	CH-04PYP-125-TL-HKU1
5	1-1/4	Conductive Rubber	220	6-5/16" (160)	4-55/64" (123)	Precision Ball	CH-05CRB-125-TL-HKU1
5	1-1/4	Thermoplastic Rubber	220	6-5/16" (160)	4-55/64" (123)	Precision Ball	CH-05TPP-125-TL-HKU1
5	1-1/4	Anti-Microbial TPR	220	6-5/16" (160)	4-55/64" (123)	Precision Ball	CH-05AMP-125-TL-HKU1
5	1-1/4	Polyurethane TPU	220	6-5/16" (160)	4-55/64" (123)	Precision Ball	CH-05PYP-125-TL-HKU1
6	1-1/4	Conductive Rubber	240	7-9/32" (185)	4-55/64" (123)	Precision Ball	CH-06CRB-125-TL-HKU1
6	1-1/4	Thermoplastic Rubber	240	7-9/32" (185)	4-55/64" (123)	Precision Ball	CH-06TPP-125-TL-HKU1
6	1-1/4	Anti-Microbial TPR	240	7-9/32" (185)	4-55/64" (123)	Precision Ball	CH-06AMP-125-TL-HKU1
6	1-1/4	Polyurethane TPU	240	7-9/32" (185)	4-55/64" (123)	Precision Ball	CH-06PYP-125-TL-HKU1



Total Lock
Change "SW"
to "TL". **Red**
sticker on pedal.

HOLLOW KINGPIN DIRECTION LOCK MODELS

(LOCKS SWIVEL ONLY)

Wheel Diameter (Inches)	Tread Width (Inches)	Wheel Description	Capacity (Lbs)	Load Height Inches (mm)	Swivel Radius Inches (mm)	Wheel Bearing	Model Number
3	1-1/4	Conductive Rubber	165	4-5/16" (109)	4-1/4" (108)	Precision Ball	CH-03CRB-125-DL-HKU1
3	1-1/4	Thermoplastic Rubber	165	4-5/16" (109)	4-1/4" (108)	Precision Ball	CH-03TPP-125-DL-HKU1
3	1-1/4	Anti-Microbial TPR	165	4-5/16" (109)	4-1/4" (108)	Precision Ball	CH-03AMP-125-DL-HKU1
3	1-1/4	Polyurethane TPU	165	4-5/16" (109)	4-1/4" (108)	Precision Ball	CH-03PYP-125-DL-HKU1
4	1-1/4	Conductive Rubber	190	5-5/16" (135)	4-35/64" (115)	Precision Ball	CH-04CRB-125-DL-HKU1
4	1-1/4	Thermoplastic Rubber	190	5-5/16" (135)	4-35/64" (115)	Precision Ball	CH-04TPP-125-DL-HKU1
4	1-1/4	Anti-Microbial TPR	190	5-5/16" (135)	4-35/64" (115)	Precision Ball	CH-04AMP-125-DL-HKU1
4	1-1/4	Polyurethane TPU	190	5-5/16" (135)	4-35/64" (115)	Precision Ball	CH-04PYP-125-DL-HKU1
5	1-1/4	Conductive Rubber	220	6-5/16" (160)	4-55/64" (123)	Precision Ball	CH-05CRB-125-DL-HKU1
5	1-1/4	Thermoplastic Rubber	220	6-5/16" (160)	4-55/64" (123)	Precision Ball	CH-05TPP-125-DL-HKU1
5	1-1/4	Anti-Microbial TPR	220	6-5/16" (160)	4-55/64" (123)	Precision Ball	CH-05AMP-125-DL-HKU1
5	1-1/4	Polyurethane TPU	220	6-5/16" (160)	4-55/64" (123)	Precision Ball	CH-05PYP-125-DL-HKU1
6	1-1/4	Conductive Rubber	240	7-9/32" (185)	4-55/64" (123)	Precision Ball	CH-06CRB-125-DL-HKU1
6	1-1/4	Thermoplastic Rubber	240	7-9/32" (185)	4-55/64" (123)	Precision Ball	CH-06TPP-125-DL-HKU1
6	1-1/4	Anti-Microbial TPR	240	7-9/32" (185)	4-55/64" (123)	Precision Ball	CH-06AMP-125-DL-HKU1
6	1-1/4	Polyurethane TPU	240	7-9/32" (185)	4-55/64" (123)	Precision Ball	CH-06PYP-125-DL-HKU1



Direction Lock
Change "SW"
to "DL". **Green**
sticker on pedal.

HOLLOW KINGPIN

Caster is provided unassembled to make it easy to add your choice of fitting. If you would like these assembled change HKU1 to HKO1. 1/2 I.D.

CHROME HOSPITAL (CH)

GRIP RING STEM MODELS

FREE SWIVEL • TOTAL LOCK • DIRECTION LOCK



APPLICATIONS

- Food Service
- Case Carts
- Utility Carts
- Hospital Equipment
- Institutional Equipment
- Store Fixtures
- Medical equipment

New larger brake pedal for easy braking action

FEATURES

- Chrome Plated Finish
- Dual Ball Swivel Raceways for added strength
- Total Lock Brake models lock both swivel and wheel
- Directional lock models lock swivel only (helps with steering)
- Precision ball bearings in wheels for easier rollability
- Wheels have full thread guards for added protection

The CH series brings you Chrome Hospital casters at an affordable price.

GRIP RING STEM MODELS

Wheel Diameter (Inches)	Tread Width (Inches)	Wheel Description	Capacity (lbs)	Load Height Inches (mm)	Swivel Radius Inches (mm)	Wheel Bearing	Model Number
3	1-1/4	Conductive Rubber	165	4-5/16" (109)	2-29/32" (74)	Annular Ball	CH-03CRB-125-SW-___
3	1-1/4	Thermoplastic Rubber	165	4-5/16" (109)	2-29/32" (74)	Precision Ball	CH-03TPP-125-SW-___
3	1-1/4	Anti-Microbial TPR	165	4-5/16" (109)	2-29/32" (74)	Precision Ball	CH-03AMP-125-SW-___
3	1-1/4	Polyurethane TPU	165	4-5/16" (109)	2-29/32" (74)	Precision Ball	CH-03PYP-125-SW-___
4	1-1/4	Conductive Rubber	165	5-5/16" (135)	3-37/64" (91)	Annular Ball	CH-04CRB-125-SW-___
4	1-1/4	Thermoplastic Rubber	190	5-5/16" (135)	3-37/64" (91)	Precision Ball	CH-04TPP-125-SW-___
4	1-1/4	Anti-Microbial TPR	190	5-5/16" (135)	3-37/64" (91)	Precision Ball	CH-04AMP-125-SW-___
4	1-1/4	Polyurethane TPU	190	5-5/16" (135)	3-37/64" (91)	Precision Ball	CH-04PYP-125-SW-___
5	1-1/4	Conductive Rubber	220	6-5/16" (160)	4-7/32" (108)	Annular Ball	CH-05CRB-125-SW-___
5	1-1/4	Thermoplastic Rubber	220	6-5/16" (160)	4-7/32" (108)	Precision Ball	CH-05TPP-125-SW-___
5	1-1/4	Anti-Microbial TPR	220	6-5/16" (160)	4-7/32" (108)	Precision Ball	CH-05AMP-125-SW-___
5	1-1/4	Polyurethane TPU	220	6-5/16" (160)	4-7/32" (108)	Precision Ball	CH-05PYP-125-SW-___
6	1-1/4	Conductive Rubber	240	7-9/32" (185)	4-39/64 (117)	Annular Ball	CH-06CRB-125-SW-___
6	1-1/4	Thermoplastic Rubber	240	7-9/32" (185)	4-39/64 (117)	Precision Ball	CH-06TPP-125-SW-___
6	1-1/4	Anti-Microbial TPR	240	7-9/32" (185)	4-39/64 (117)	Precision Ball	CH-06AMP-125-SW-___
6	1-1/4	Polyurethane TPU	240	7-9/32" (185)	4-39/64 (117)	Precision Ball	CH-06PYP-125-SW-___



Anti-Microbial wheels have light green tread.



Specify Grip Ring Stem (GR) code, see fittings at left for dimensions.

GRIP RING STEM FITTINGS

See fittings page for more options.

GR02	GR04	GR05	GR06	GR07	GR09	GR10
1-7/16"	1-5/8"	1-5/8"	2"	1-7/8"	2-3/16"	1-3/8"
7/16"	5/8"	3/4"	7/8"	1"	.845"	.7/16"

CHROME HOSPITAL (CH)

GRIP RING STEM TOTAL LOCK MODELS (LOCKS WHEEL AND SWIVEL)

Wheel Diameter (Inches)	Tread Width (Inches)	Wheel Description	Capacity (Lbs)	Load Height Inches (mm)	Swivel Radius Inches (mm)	Wheel Bearing	Model Number
3	1-1/4	Conductive Rubber	165	4-5/16" (109)	4-1/4" (108)	Precision Ball	CH-03CRB-125-TL-____
3	1-1/4	Thermoplastic Rubber	165	4-5/16" (109)	4-1/4" (108)	Precision Ball	CH-03TPP-125-TL-____
3	1-1/4	Anti-Microbial TPR	165	4-5/16" (109)	4-1/4" (108)	Precision Ball	CH-03AMP-125-TL-____
3	1-1/4	Polyurethane TPU	165	4-5/16" (109)	4-1/4" (108)	Precision Ball	CH-03PYP-125-TL-____
4	1-1/4	Conductive Rubber	190	5-5/16" (135)	4-35/64" (115)	Precision Ball	CH-04CRB-125-TL-____
4	1-1/4	Thermoplastic Rubber	190	5-5/16" (135)	4-35/64" (115)	Precision Ball	CH-04TPP-125-TL-____
4	1-1/4	Anti-Microbial TPR	190	5-5/16" (135)	4-35/64" (115)	Precision Ball	CH-04AMP-125-TL-____
4	1-1/4	Polyurethane TPU	190	5-5/16" (135)	4-35/64" (115)	Precision Ball	CH-04PYP-125-TL-____
5	1-1/4	Conductive Rubber	220	6-5/16" (160)	4-55/64" (123)	Precision Ball	CH-05CRB-125-TL-____
5	1-1/4	Thermoplastic Rubber	220	6-5/16" (160)	4-55/64" (123)	Precision Ball	CH-05TPP-125-TL-____
5	1-1/4	Anti-Microbial TPR	220	6-5/16" (160)	4-55/64" (123)	Precision Ball	CH-05AMP-125-TL-____
5	1-1/4	Polyurethane TPU	220	6-5/16" (160)	4-55/64" (123)	Precision Ball	CH-05PYP-125-TL-____
6	1-1/4	Conductive Rubber	240	7-9/32" (185)	4-55/64" (123)	Precision Ball	CH-06CRB-125-TL-____
6	1-1/4	Thermoplastic Rubber	240	7-9/32" (185)	4-55/64" (123)	Precision Ball	CH-06TPP-125-TL-____
6	1-1/4	Anti-Microbial TPR	240	7-9/32" (185)	4-55/64" (123)	Precision Ball	CH-06AMP-125-TL-____
6	1-1/4	Polyurethane TPU	240	7-9/32" (185)	4-55/64" (123)	Precision Ball	CH-06PYP-125-TL-____



Total Lock
Change "SW"
to "TL". Red
sticker on pedal.

GRIP RING STEM DIRECTION LOCK MODELS (LOCKS SWIVEL ONLY)

Wheel Diameter (Inches)	Tread Width (Inches)	Wheel Description	Capacity (Lbs)	Load Height Inches (mm)	Swivel Radius Inches (mm)	Wheel Bearing	Model Number
3	1-1/4	Conductive Rubber	165	4-5/16" (109)	4-1/4" (108)	Precision Ball	CH-03CRB-125-DL-____
3	1-1/4	Thermoplastic Rubber	165	4-5/16" (109)	4-1/4" (108)	Precision Ball	CH-03TPP-125-DL-____
3	1-1/4	Anti-Microbial TPR	165	4-5/16" (109)	4-1/4" (108)	Precision Ball	CH-03AMP-125-DL-____
3	1-1/4	Polyurethane TPU	165	4-5/16" (109)	4-1/4" (108)	Precision Ball	CH-03PYP-125-DL-____
4	1-1/4	Conductive Rubber	190	5-5/16" (135)	4-35/64" (115)	Precision Ball	CH-04CRB-125-DL-____
4	1-1/4	Thermoplastic Rubber	190	5-5/16" (135)	4-35/64" (115)	Precision Ball	CH-04TPP-125-DL-____
4	1-1/4	Anti-Microbial TPR	190	5-5/16" (135)	4-35/64" (115)	Precision Ball	CH-04AMP-125-DL-____
4	1-1/4	Polyurethane TPU	190	5-5/16" (135)	4-35/64" (115)	Precision Ball	CH-04PYP-125-DL-____
5	1-1/4	Conductive Rubber	220	6-5/16" (160)	4-55/64" (123)	Precision Ball	CH-05CRB-125-DL-____
5	1-1/4	Thermoplastic Rubber	220	6-5/16" (160)	4-55/64" (123)	Precision Ball	CH-05TPP-125-DL-____
5	1-1/4	Anti-Microbial TPR	220	6-5/16" (160)	4-55/64" (123)	Precision Ball	CH-05AMP-125-DL-____
5	1-1/4	Polyurethane TPU	220	6-5/16" (160)	4-55/64" (123)	Precision Ball	CH-05PYP-125-DL-____
6	1-1/4	Conductive Rubber	240	7-9/32" (185)	4-55/64" (123)	Precision Ball	CH-06CRB-125-DL-____
6	1-1/4	Thermoplastic Rubber	240	7-9/32" (185)	4-55/64" (123)	Precision Ball	CH-06TPP-125-DL-____
6	1-1/4	Anti-Microbial TPR	240	7-9/32" (185)	4-55/64" (123)	Precision Ball	CH-06AMP-125-DL-____
6	1-1/4	Polyurethane TPU	240	7-9/32" (185)	4-55/64" (123)	Precision Ball	CH-06PYP-125-DL-____



Direction Lock
Change "SW"
to "DL". Green
sticker on pedal.

Specify Grip Ring Stem (GR) code, see fittings at left for dimensions.

GRIP RING STEM FITTINGS

See fittings page for more options.

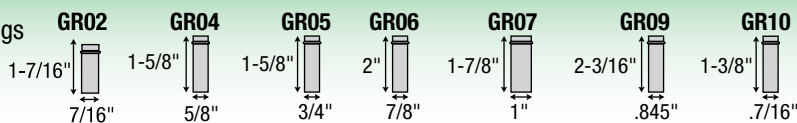

CHROME HOSPITAL (CH)

EXPANDING ADAPTER STEM MODELS
FREE SWIVEL • TOTAL LOCK • DIRECTION LOCK



APPLICATIONS

- Food Service
- Case Carts
- Utility Carts
- Hospital Equipment
- Institutional Equipment
- Store Fixtures
- Medical equipment

New larger brake pedal for easy braking action

FEATURES

- Chrome Plated Finish
- Dual Ball Swivel Raceways for added strength
- Total Lock Brake models lock both swivel and wheel
- Directional lock models lock swivel only (helps with steering)
- Precision ball bearings in wheels for easier rollability
- Wheels have full thread guards for added protection

The CH series brings you Chrome Hospital casters at an affordable price.

EXPANDING ADAPTER STEM MODELS

Wheel Diameter (Inches)	Tread Width (Inches)	Wheel Description	Capacity (Lbs)	Load Height Inches (mm)	Swivel Radius Inches (mm)	Wheel Bearing	Model Number
3	1-1/4	Conductive Rubber	165	4-5/16" (109)	2-29/32" (74)	Annular Ball	CH-03CRB-125-SW-___
3	1-1/4	Thermoplastic Rubber	165	4-5/16" (109)	2-29/32" (74)	Precision Ball	CH-03TPP-125-SW-___
3	1-1/4	Anti-Microbial TPR	165	4-5/16" (109)	2-29/32" (74)	Precision Ball	CH-03AMP-125-SW-___
3	1-1/4	Polyurethane TPU	165	4-5/16" (109)	2-29/32" (74)	Precision Ball	CH-03PYP-125-SW-___
4	1-1/4	Conductive Rubber	165	5-5/16" (135)	3-37/64" (91)	Annular Ball	CH-04CRB-125-SW-___
4	1-1/4	Thermoplastic Rubber	190	5-5/16" (135)	3-37/64" (91)	Precision Ball	CH-04TPP-125-SW-___
4	1-1/4	Anti-Microbial TPR	190	5-5/16" (135)	3-37/64" (91)	Precision Ball	CH-04AMP-125-SW-___
4	1-1/4	Polyurethane TPU	190	5-5/16" (135)	3-37/64" (91)	Precision Ball	CH-04PYP-125-SW-___
5	1-1/4	Conductive Rubber	220	6-5/16" (160)	4-7/32" (108)	Annular Ball	CH-05CRB-125-SW-___
5	1-1/4	Thermoplastic Rubber	220	6-5/16" (160)	4-7/32" (108)	Precision Ball	CH-05TPP-125-SW-___
5	1-1/4	Anti-Microbial TPR	220	6-5/16" (160)	4-7/32" (108)	Precision Ball	CH-05AMP-125-SW-___
5	1-1/4	Polyurethane TPU	220	6-5/16" (160)	4-7/32" (108)	Precision Ball	CH-05PYP-125-SW-___
6	1-1/4	Conductive Rubber	240	7-9/32" (185)	4-39/64 (117)	Annular Ball	CH-06CRB-125-SW-___
6	1-1/4	Thermoplastic Rubber	240	7-9/32" (185)	4-39/64 (117)	Precision Ball	CH-06TPP-125-SW-___
6	1-1/4	Anti-Microbial TPR	240	7-9/32" (185)	4-39/64 (117)	Precision Ball	CH-06AMP-125-SW-___
6	1-1/4	Polyurethane TPU	240	7-9/32" (185)	4-39/64 (117)	Precision Ball	CH-06PYP-125-SW-___



Anti-Microbial wheels have light green tread.



Specify Expanding Adapter Stem (XR) code, see fittings at left for dimensions.

EXPANDING ADAPTER STEM FITTINGS

See fittings page for descriptions and more options.

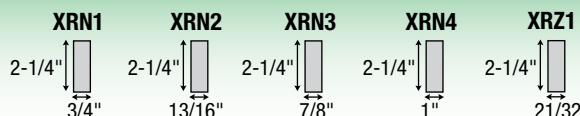

CHROME HOSPITAL (CH)

EXPANDING ADAPTER STEM TOTAL LOCK MODELS (LOCKS WHEEL AND SWIVEL)

Wheel Diameter (Inches)	Tread Width (Inches)	Wheel Description	Capacity (Lbs)	Load Height Inches (mm)	Swivel Radius Inches (mm)	Wheel Bearing	Model Number
3	1-1/4	Conductive Rubber	165	4-5/16" (109)	4-1/4" (108)	Precision Ball	CH-03CRB-125-TL-_____
3	1-1/4	Thermoplastic Rubber	165	4-5/16" (109)	4-1/4" (108)	Precision Ball	CH-03TPP-125-TL-_____
3	1-1/4	Anti-Microbial TPR	165	4-5/16" (109)	4-1/4" (108)	Precision Ball	CH-03AMP-125-TL-_____
3	1-1/4	Polyurethane TPU	165	4-5/16" (109)	4-1/4" (108)	Precision Ball	CH-03PYP-125-TL-_____
4	1-1/4	Conductive Rubber	190	5-5/16" (135)	4-35/64" (115)	Precision Ball	CH-04CRB-125-TL-_____
4	1-1/4	Thermoplastic Rubber	190	5-5/16" (135)	4-35/64" (115)	Precision Ball	CH-04TPP-125-TL-_____
4	1-1/4	Anti-Microbial TPR	190	5-5/16" (135)	4-35/64" (115)	Precision Ball	CH-04AMP-125-TL-_____
4	1-1/4	Polyurethane TPU	190	5-5/16" (135)	4-35/64" (115)	Precision Ball	CH-04PYP-125-TL-_____
5	1-1/4	Conductive Rubber	220	6-5/16" (160)	4-55/64" (123)	Precision Ball	CH-05CRB-125-TL-_____
5	1-1/4	Thermoplastic Rubber	220	6-5/16" (160)	4-55/64" (123)	Precision Ball	CH-05TPP-125-TL-_____
5	1-1/4	Anti-Microbial TPR	220	6-5/16" (160)	4-55/64" (123)	Precision Ball	CH-05AMP-125-TL-_____
5	1-1/4	Polyurethane TPU	220	6-5/16" (160)	4-55/64" (123)	Precision Ball	CH-05PYP-125-TL-_____
6	1-1/4	Conductive Rubber	240	7-9/32" (185)	4-55/64" (123)	Precision Ball	CH-06CRB-125-TL-_____
6	1-1/4	Thermoplastic Rubber	240	7-9/32" (185)	4-55/64" (123)	Precision Ball	CH-06TPP-125-TL-_____
6	1-1/4	Anti-Microbial TPR	240	7-9/32" (185)	4-55/64" (123)	Precision Ball	CH-06AMP-125-TL-_____
6	1-1/4	Polyurethane TPU	240	7-9/32" (185)	4-55/64" (123)	Precision Ball	CH-06PYP-125-TL-_____



Total Lock
Change "SW"
to "TL". Red
sticker on pedal.

EXPANDING ADAPTER STEM DIRECTION LOCK MODELS (LOCKS SWIVEL ONLY)

Wheel Diameter (Inches)	Tread Width (Inches)	Wheel Description	Capacity (Lbs)	Load Height Inches (mm)	Swivel Radius Inches (mm)	Wheel Bearing	Model Number
3	1-1/4	Conductive Rubber	165	4-5/16" (109)	4-1/4" (108)	Precision Ball	CH-03CRB-125-DL-_____
3	1-1/4	Thermoplastic Rubber	165	4-5/16" (109)	4-1/4" (108)	Precision Ball	CH-03TPP-125-DL-_____
3	1-1/4	Anti-Microbial TPR	165	4-5/16" (109)	4-1/4" (108)	Precision Ball	CH-03AMP-125-DL-_____
3	1-1/4	Polyurethane TPU	165	4-5/16" (109)	4-1/4" (108)	Precision Ball	CH-03PYP-125-DL-_____
4	1-1/4	Conductive Rubber	190	5-5/16" (135)	4-35/64" (115)	Precision Ball	CH-04CRB-125-DL-_____
4	1-1/4	Thermoplastic Rubber	190	5-5/16" (135)	4-35/64" (115)	Precision Ball	CH-04TPP-125-DL-_____
4	1-1/4	Anti-Microbial TPR	190	5-5/16" (135)	4-35/64" (115)	Precision Ball	CH-04AMP-125-DL-_____
4	1-1/4	Polyurethane TPU	190	5-5/16" (135)	4-35/64" (115)	Precision Ball	CH-04PYP-125-DL-_____
5	1-1/4	Conductive Rubber	220	6-5/16" (160)	4-55/64" (123)	Precision Ball	CH-05CRB-125-DL-_____
5	1-1/4	Thermoplastic Rubber	220	6-5/16" (160)	4-55/64" (123)	Precision Ball	CH-05TPP-125-DL-_____
5	1-1/4	Anti-Microbial TPR	220	6-5/16" (160)	4-55/64" (123)	Precision Ball	CH-05AMP-125-DL-_____
5	1-1/4	Polyurethane TPU	220	6-5/16" (160)	4-55/64" (123)	Precision Ball	CH-05PYP-125-DL-_____
6	1-1/4	Conductive Rubber	240	7-9/32" (185)	4-55/64" (123)	Precision Ball	CH-06CRB-125-DL-_____
6	1-1/4	Thermoplastic Rubber	240	7-9/32" (185)	4-55/64" (123)	Precision Ball	CH-06TPP-125-DL-_____
6	1-1/4	Anti-Microbial TPR	240	7-9/32" (185)	4-55/64" (123)	Precision Ball	CH-06AMP-125-DL-_____
6	1-1/4	Polyurethane TPU	240	7-9/32" (185)	4-55/64" (123)	Precision Ball	CH-06PYP-125-DL-_____



Direction Lock
Change "SW"
to "DL". Green
sticker on pedal.

Specify Expanding Adapter Stem (XR) code, see fittings at left for dimensions.

EXPANDING ADAPTER STEM FITTINGS

See fittings page for descriptions and more options.

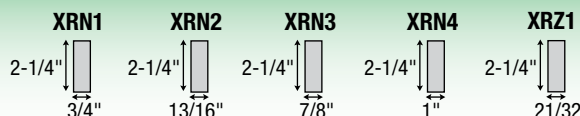

CHROME HOSPITAL (CH)

THREADED STEM MODELS

FREE SWIVEL • TOTAL LOCK • DIRECTION LOCK



APPLICATIONS

- Food Service
- Case Carts
- Utility Carts
- Hospital Equipment
- Institutional Equipment
- Store Fixtures
- Medical equipment

New larger brake pedal for easy braking action

FEATURES

- Chrome Plated Finish
- Dual Ball Swivel Raceways for added strength
- Total Lock Brake models lock both swivel and wheel
- Directional lock models lock swivel only (helps with Steering)
- Precision ball bearings in wheels for easier rollability
- Wheels have full thread guards for added protection

The CH series brings you Chrome Hospital casters at an affordable price.

THREADED STEM MODELS

Wheel Diameter (Inches)	Tread Width (Inches)	Wheel Description	Capacity (Lbs)	Load Height Inches (mm)	Swivel Radius Inches (mm)	Wheel Bearing	Model Number
3	1-1/4	Conductive Rubber	165	4-5/16" (109)	2-29/32" (74)	Annular Ball	CH-03CRB-125-SW-____
3	1-1/4	Thermoplastic Rubber	165	4-5/16" (109)	2-29/32" (74)	Precision Ball	CH-03TPP-125-SW-____
3	1-1/4	Anti-Microbial TPR	165	4-5/16" (109)	2-29/32" (74)	Precision Ball	CH-03AMP-125-SW-____
3	1-1/4	Polyurethane TPU	165	4-5/16" (109)	2-29/32" (74)	Precision Ball	CH-03PYP-125-SW-____
4	1-1/4	Conductive Rubber	165	5-5/16" (135)	3-37/64" (91)	Annular Ball	CH-04CRB-125-SW-____
4	1-1/4	Thermoplastic Rubber	190	5-5/16" (135)	3-37/64" (91)	Precision Ball	CH-04TPP-125-SW-____
4	1-1/4	Anti-Microbial TPR	190	5-5/16" (135)	3-37/64" (91)	Precision Ball	CH-04AMP-125-SW-____
4	1-1/4	Polyurethane TPU	190	5-5/16" (135)	3-37/64" (91)	Precision Ball	CH-04PYP-125-SW-____
5	1-1/4	Conductive Rubber	220	6-5/16" (160)	4-7/32" (108)	Annular Ball	CH-05CRB-125-SW-____
5	1-1/4	Thermoplastic Rubber	220	6-5/16" (160)	4-7/32" (108)	Precision Ball	CH-05TPP-125-SW-____
5	1-1/4	Anti-Microbial TPR	220	6-5/16" (160)	4-7/32" (108)	Precision Ball	CH-05AMP-125-SW-____
5	1-1/4	Polyurethane TPU	220	6-5/16" (160)	4-7/32" (108)	Precision Ball	CH-05PYP-125-SW-____
6	1-1/4	Conductive Rubber	240	7-9/32" (185)	4-39/64 (117)	Annular Ball	CH-06CRB-125-SW-____
6	1-1/4	Thermoplastic Rubber	240	7-9/32" (185)	4-39/64 (117)	Precision Ball	CH-06TPP-125-SW-____
6	1-1/4	Anti-Microbial TPR	240	7-9/32" (185)	4-39/64 (117)	Precision Ball	CH-06AMP-125-SW-____
6	1-1/4	Polyurethane TPU	240	7-9/32" (185)	4-39/64 (117)	Precision Ball	CH-06PYP-125-SW-____



Anti-Microbial wheels have light green tread.



Specify Threaded Stem (TS) code, see fittings at left for dimensions:

THREADED STEM FITTINGS

See fittings page for more easy to install stem options.

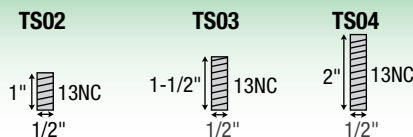

CHROME HOSPITAL (CH)

THREADED STEM TOTAL LOCK MODELS (LOCKS WHEEL AND SWIVEL)

Wheel Diameter (Inches)	Tread Width (Inches)	Wheel Description	Capacity (Lbs)	Load Height Inches (mm)	Swivel Radius Inches (mm)	Wheel Bearing	Model Number
3	1-1/4	Conductive Rubber	165	4-5/16" (109)	4-1/4" (108)	Precision Ball	CH-03CRB-125-TL-_____
3	1-1/4	Thermoplastic Rubber	165	4-5/16" (109)	4-1/4" (108)	Precision Ball	CH-03TPP-125-TL-_____
3	1-1/4	Anti-Microbial TPR	165	4-5/16" (109)	4-1/4" (108)	Precision Ball	CH-03AMP-125-TL-_____
3	1-1/4	Polyurethane TPU	165	4-5/16" (109)	4-1/4" (108)	Precision Ball	CH-03PYP-125-TL-_____
4	1-1/4	Conductive Rubber	190	5-5/16" (135)	4-35/64" (115)	Precision Ball	CH-04CRB-125-TL-_____
4	1-1/4	Thermoplastic Rubber	190	5-5/16" (135)	4-35/64" (115)	Precision Ball	CH-04TPP-125-TL-_____
4	1-1/4	Anti-Microbial TPR	190	5-5/16" (135)	4-35/64" (115)	Precision Ball	CH-04AMP-125-TL-_____
4	1-1/4	Polyurethane TPU	190	5-5/16" (135)	4-35/64" (115)	Precision Ball	CH-04PYP-125-TL-_____
5	1-1/4	Conductive Rubber	220	6-5/16" (160)	4-55/64" (123)	Precision Ball	CH-05CRB-125-TL-_____
5	1-1/4	Thermoplastic Rubber	220	6-5/16" (160)	4-55/64" (123)	Precision Ball	CH-05TPP-125-TL-_____
5	1-1/4	Anti-Microbial TPR	220	6-5/16" (160)	4-55/64" (123)	Precision Ball	CH-05AMP-125-TL-_____
5	1-1/4	Polyurethane TPU	220	6-5/16" (160)	4-55/64" (123)	Precision Ball	CH-05PYP-125-TL-_____
6	1-1/4	Conductive Rubber	240	7-9/32" (185)	4-55/64" (123)	Precision Ball	CH-06CRB-125-TL-_____
6	1-1/4	Thermoplastic Rubber	240	7-9/32" (185)	4-55/64" (123)	Precision Ball	CH-06TPP-125-TL-_____
6	1-1/4	Anti-Microbial TPR	240	7-9/32" (185)	4-55/64" (123)	Precision Ball	CH-06AMP-125-TL-_____
6	1-1/4	Polyurethane TPU	240	7-9/32" (185)	4-55/64" (123)	Precision Ball	CH-06PYP-125-TL-_____



Total Lock
Change "SW"
to "TL". **Red**
sticker on pedal.

THREADED STEM DIRECTION LOCK MODELS (LOCKS SWIVEL ONLY)

Wheel Diameter (Inches)	Tread Width (Inches)	Wheel Description	Capacity (Lbs)	Load Height Inches (mm)	Swivel Radius Inches (mm)	Wheel Bearing	Model Number
3	1-1/4	Conductive Rubber	165	4-5/16" (109)	4-1/4" (108)	Precision Ball	CH-03CRB-125-DL-_____
3	1-1/4	Thermoplastic Rubber	165	4-5/16" (109)	4-1/4" (108)	Precision Ball	CH-03TPP-125-DL-_____
3	1-1/4	Anti-Microbial TPR	165	4-5/16" (109)	4-1/4" (108)	Precision Ball	CH-03AMP-125-DL-_____
3	1-1/4	Polyurethane TPU	165	4-5/16" (109)	4-1/4" (108)	Precision Ball	CH-03PYP-125-DL-_____
4	1-1/4	Conductive Rubber	190	5-5/16" (135)	4-35/64" (115)	Precision Ball	CH-04CRB-125-DL-_____
4	1-1/4	Thermoplastic Rubber	190	5-5/16" (135)	4-35/64" (115)	Precision Ball	CH-04TPP-125-DL-_____
4	1-1/4	Anti-Microbial TPR	190	5-5/16" (135)	4-35/64" (115)	Precision Ball	CH-04AMP-125-DL-_____
4	1-1/4	Polyurethane TPU	190	5-5/16" (135)	4-35/64" (115)	Precision Ball	CH-04PYP-125-DL-_____
5	1-1/4	Conductive Rubber	220	6-5/16" (160)	4-55/64" (123)	Precision Ball	CH-05CRB-125-DL-_____
5	1-1/4	Thermoplastic Rubber	220	6-5/16" (160)	4-55/64" (123)	Precision Ball	CH-05TPP-125-DL-_____
5	1-1/4	Anti-Microbial TPR	220	6-5/16" (160)	4-55/64" (123)	Precision Ball	CH-05AMP-125-DL-_____
5	1-1/4	Polyurethane TPU	220	6-5/16" (160)	4-55/64" (123)	Precision Ball	CH-05PYP-125-DL-_____
6	1-1/4	Conductive Rubber	240	7-9/32" (185)	4-55/64" (123)	Precision Ball	CH-06CRB-125-DL-_____
6	1-1/4	Thermoplastic Rubber	240	7-9/32" (185)	4-55/64" (123)	Precision Ball	CH-06TPP-125-DL-_____
6	1-1/4	Anti-Microbial TPR	240	7-9/32" (185)	4-55/64" (123)	Precision Ball	CH-06AMP-125-DL-_____
6	1-1/4	Polyurethane TPU	240	7-9/32" (185)	4-55/64" (123)	Precision Ball	CH-06PYP-125-DL-_____



Direction Lock
Change "SW"
to "DL". **Green**
sticker on pedal.

Specify Threaded Stem
(TS) code, see fittings at
left for dimensions:

THREADED STEM FITTINGS

See fittings page for more easy to install stem options.

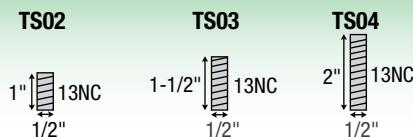

CHROME HOSPITAL (CH)

ROUND/SQUARE STEM MODELS
FREE SWIVEL • TOTAL LOCK • DIRECTION LOCK



- APPLICATIONS**
- Food Service
 - Case Carts
 - Utility Carts
 - Hospital Equipment
 - Institutional Equipment
 - Store Fixtures
 - Medical equipment

New larger brake pedal for easy braking action

- FEATURES**
- Chrome Plated Finish
 - Dual Ball Swivel Raceways for added strength
 - Total Lock Brake models lock both swivel and wheel
 - Directional lock models lock swivel only (helps with steering)
 - Precision ball bearings in wheels for easier rollability
 - Wheels have full thread guards for added protection

The CH series brings you Chrome Hospital casters at an affordable price.

SQUARE/ROUND STEM FREE SWIVEL MODELS

Wheel Diameter (Inches)	Tread Width (Inches)	Wheel Description	Capacity (Lbs)	Load Height Inches (mm)	Swivel Radius Inches (mm)	Wheel Bearing	Model Number
3	1-1/4	Conductive Rubber	165	4-5/16" (109)	2-29/32" (74)	Annular Ball	CH-03CRB-125-SW-___
3	1-1/4	Thermoplastic Rubber	165	4-5/16" (109)	2-29/32" (74)	Precision Ball	CH-03TPP-125-SW-___
3	1-1/4	Anti-Microbial TPR	165	4-5/16" (109)	2-29/32" (74)	Precision Ball	CH-03AMP-125-SW-___
3	1-1/4	Polyurethane TPU	165	4-5/16" (109)	2-29/32" (74)	Precision Ball	CH-03PYP-125-SW-___
4	1-1/4	Conductive Rubber	165	5-5/16" (135)	3-37/64" (91)	Annular Ball	CH-04CRB-125-SW-___
4	1-1/4	Thermoplastic Rubber	190	5-5/16" (135)	3-37/64" (91)	Precision Ball	CH-04TPP-125-SW-___
4	1-1/4	Anti-Microbial TPR	190	5-5/16" (135)	3-37/64" (91)	Precision Ball	CH-04AMP-125-SW-___
4	1-1/4	Polyurethane TPU	190	5-5/16" (135)	3-37/64" (91)	Precision Ball	CH-04PYP-125-SW-___
5	1-1/4	Conductive Rubber	220	6-5/16" (160)	4-7/32" (108)	Annular Ball	CH-05CRB-125-SW-___
5	1-1/4	Thermoplastic Rubber	220	6-5/16" (160)	4-7/32" (108)	Precision Ball	CH-05TPP-125-SW-___
5	1-1/4	Anti-Microbial TPR	220	6-5/16" (160)	4-7/32" (108)	Precision Ball	CH-05AMP-125-SW-___
5	1-1/4	Polyurethane TPU	220	6-5/16" (160)	4-7/32" (108)	Precision Ball	CH-05PYP-125-SW-___
6	1-1/4	Conductive Rubber	240	7-9/32" (185)	4-39/64 (117)	Annular Ball	CH-06CRB-125-SW-___
6	1-1/4	Thermoplastic Rubber	240	7-9/32" (185)	4-39/64 (117)	Precision Ball	CH-06TPP-125-SW-___
6	1-1/4	Anti-Microbial TPR	240	7-9/32" (185)	4-39/64 (117)	Precision Ball	CH-06AMP-125-SW-___
6	1-1/4	Polyurethane TPU	240	7-9/32" (185)	4-39/64 (117)	Precision Ball	CH-06PYP-125-SW-___



Rigid models available. Consult factory.

Anti-Microbial wheels have light green tread.



ROUND STEM FITTINGS

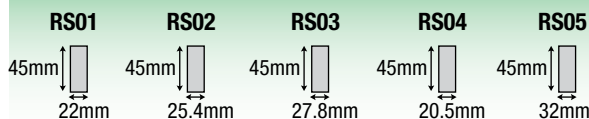

SQUARE STEM FITTINGS

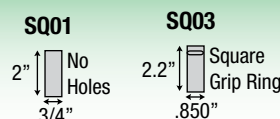

Specify Round Stem (RS) code, Square stem specify (SQ) code. see fittings at left for dimensions..

See fittings page for more options.



CHROME HOSPITAL (CH)

SQUARE/ROUND STEM TOTAL LOCK MODELS (LOCKS WHEEL AND SWIVEL)

Wheel Diameter (Inches)	Tread Width (Inches)	Wheel Description	Capacity (Lbs)	Load Height Inches (mm)	Swivel Radius Inches (mm)	Wheel Bearing	Model Number
3	1-1/4	Conductive Rubber	165	4-5/16" (109)	4-1/4" (108)	Precision Ball	CH-03CRB-125-TL-____
3	1-1/4	Thermoplastic Rubber	165	4-5/16" (109)	4-1/4" (108)	Precision Ball	CH-03TPP-125-TL-____
3	1-1/4	Anti-Microbial TPR	165	4-5/16" (109)	4-1/4" (108)	Precision Ball	CH-03AMP-125-TL-____
3	1-1/4	Polyurethane TPU	165	4-5/16" (109)	4-1/4" (108)	Precision Ball	CH-03PYP-125-TL-____
4	1-1/4	Conductive Rubber	190	5-5/16" (135)	4-35/64" (115)	Precision Ball	CH-04CRB-125-TL-____
4	1-1/4	Thermoplastic Rubber	190	5-5/16" (135)	4-35/64" (115)	Precision Ball	CH-04TPP-125-TL-____
4	1-1/4	Anti-Microbial TPR	190	5-5/16" (135)	4-35/64" (115)	Precision Ball	CH-04AMP-125-TL-____
4	1-1/4	Polyurethane TPU	190	5-5/16" (135)	4-35/64" (115)	Precision Ball	CH-04PYP-125-TL-____
5	1-1/4	Conductive Rubber	220	6-5/16" (160)	4-55/64" (123)	Precision Ball	CH-05CRB-125-TL-____
5	1-1/4	Thermoplastic Rubber	220	6-5/16" (160)	4-55/64" (123)	Precision Ball	CH-05TPP-125-TL-____
5	1-1/4	Anti-Microbial TPR	220	6-5/16" (160)	4-55/64" (123)	Precision Ball	CH-05AMP-125-TL-____
5	1-1/4	Polyurethane TPU	220	6-5/16" (160)	4-55/64" (123)	Precision Ball	CH-05PYP-125-TL-____
6	1-1/4	Conductive Rubber	240	7-9/32" (185)	4-55/64" (123)	Precision Ball	CH-06CRB-125-TL-____
6	1-1/4	Thermoplastic Rubber	240	7-9/32" (185)	4-55/64" (123)	Precision Ball	CH-06TPP-125-TL-____
6	1-1/4	Anti-Microbial TPR	240	7-9/32" (185)	4-55/64" (123)	Precision Ball	CH-06AMP-125-TL-____
6	1-1/4	Polyurethane TPU	240	7-9/32" (185)	4-55/64" (123)	Precision Ball	CH-06PYP-125-TL-____



Total Lock
Change "SW" to "TL". Red sticker on pedal.

SQUARE/ROUND STEM DIRECTION LOCK MODELS (LOCKS SWIVEL ONLY)

Wheel Diameter (Inches)	Tread Width (Inches)	Wheel Description	Capacity (Lbs)	Load Height Inches (mm)	Swivel Radius Inches (mm)	Wheel Bearing	Model Number
3	1-1/4	Conductive Rubber	165	4-5/16" (109)	4-1/4" (108)	Precision Ball	CH-03CRB-125-DL-____
3	1-1/4	Thermoplastic Rubber	165	4-5/16" (109)	4-1/4" (108)	Precision Ball	CH-03TPP-125-DL-____
3	1-1/4	Anti-Microbial TPR	165	4-5/16" (109)	4-1/4" (108)	Precision Ball	CH-03AMP-125-DL-____
3	1-1/4	Polyurethane TPU	165	4-5/16" (109)	4-1/4" (108)	Precision Ball	CH-03PYP-125-DL-____
4	1-1/4	Conductive Rubber	190	5-5/16" (135)	4-35/64" (115)	Precision Ball	CH-04CRB-125-DL-____
4	1-1/4	Thermoplastic Rubber	190	5-5/16" (135)	4-35/64" (115)	Precision Ball	CH-04TPP-125-DL-____
4	1-1/4	Anti-Microbial TPR	190	5-5/16" (135)	4-35/64" (115)	Precision Ball	CH-04AMP-125-DL-____
4	1-1/4	Polyurethane TPU	190	5-5/16" (135)	4-35/64" (115)	Precision Ball	CH-04PYP-125-DL-____
5	1-1/4	Conductive Rubber	220	6-5/16" (160)	4-55/64" (123)	Precision Ball	CH-05CRB-125-DL-____
5	1-1/4	Thermoplastic Rubber	220	6-5/16" (160)	4-55/64" (123)	Precision Ball	CH-05TPP-125-DL-____
5	1-1/4	Anti-Microbial TPR	220	6-5/16" (160)	4-55/64" (123)	Precision Ball	CH-05AMP-125-DL-____
5	1-1/4	Polyurethane TPU	220	6-5/16" (160)	4-55/64" (123)	Precision Ball	CH-05PYP-125-DL-____
6	1-1/4	Conductive Rubber	240	7-9/32" (185)	4-55/64" (123)	Precision Ball	CH-06CRB-125-DL-____
6	1-1/4	Thermoplastic Rubber	240	7-9/32" (185)	4-55/64" (123)	Precision Ball	CH-06TPP-125-DL-____
6	1-1/4	Anti-Microbial TPR	240	7-9/32" (185)	4-55/64" (123)	Precision Ball	CH-06AMP-125-DL-____
6	1-1/4	Polyurethane TPU	240	7-9/32" (185)	4-55/64" (123)	Precision Ball	CH-06PYP-125-DL-____



Direction Lock
Change "SW" to "DL". Green sticker on pedal.

ROUND STEM FITTINGS

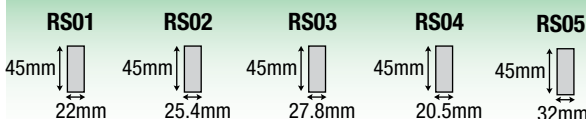

SQUARE STEM FITTINGS

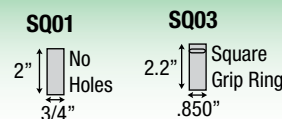

Specify Round Stem (RS) code, Square stem specify (SQ) code. see fittings at left for dimensions..

CHROME STEEL (CS)

SWIVEL TOP PLATE MODELS

FREE SWIVEL • TOTAL LOCK • DIRECTION LOCK



- APPLICATIONS**
- Food Service
 - Case Carts
 - Utility Carts
 - Medical Equipment
 - Institutional Equipment
 - Hospital Carts
 - Pharmaceutical Equipment

- FEATURES**
- Dual Ball Swivel Raceways for added strength
 - Total Lock Brake models lock both swivel and wheel
 - Directional lock models lock swivel only (helps with Steering)
 - Wheels available with Precision ball bearings or spanner bushing
 - Wheels with Precision Bearings have Full Plastic thread guards for added protection
 - Bright Chrome Finish

Chrome Steel casters that look and meet the European standards.

SWIVEL TOP PLATE MODELS

Wheel Diameter inches (mm)	Tread Width (inches)	Wheel Description	Capacity (Lbs)	Load Height inches (mm)	Swivel Radius inches (mm)	Wheel Bearing	Model Number
4" (100)	1-1/4	Neoprene Rubber	190	5-1/2" (140)	3-15/32" (88)	Precision Ball	CS-04NRP-125-SW-TP01
4" (100)	1-1/4	Thermoplastic Rubber	190	5-1/2" (140)	3-15/32" (88)	Precision Ball	CS-04TPP-125-SW-TP01
4" (100)	1-1/4	Thermoplastic Rubber	190	5-1/2" (140)	3-15/32" (88)	Plain Bore	CS-04TPO-125-SW-TP01
4" (100)	1-1/4	Polyurethane TPU	190	5-1/2" (140)	3-15/32" (88)	Precision Ball	CS-04PYP-125-SW-TP01
5" (125)	1-1/4	Neoprene Rubber	220	6-1/2" (165)	4-3/32" (104)	Precision Ball	CS-05NRP-125-SW-TP01
5" (125)	1-1/4	Thermoplastic Rubber	220	6-1/2" (165)	4-3/32" (104)	Precision Ball	CS-05TPP-125-SW-TP01
5" (125)	1-1/4	Thermoplastic Rubber	220	6-1/2" (165)	4-3/32" (104)	Plain Bore	CS-05TPO-125-SW-TP01
5" (125)	1-1/4	Polyurethane TPU	220	6-1/2" (165)	4-3/32" (104)	Precision Ball	CS-05PYP-125-SW-TP01



TOP PLATE FITTING

Swivel Top Plate Pattern

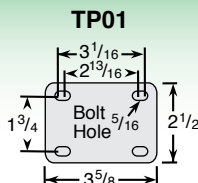

CHROME STEEL (CS)

SWIVEL TOP PLATE MODELS

FREE SWIVEL • TOTAL LOCK • DIRECTION LOCK

SWIVEL TOP PLATE TOTAL LOCK MODELS (WHEEL AND SWIVEL)

Wheel Diameter inches (mm)	Tread Width (inches)	Wheel Description	Capacity (lbs)	Load Height inches (mm)	Swivel Radius inches (mm)	Wheel Bearing	Model Number
4" (100)	1-1/4	Neoprene Rubber	190	5-1/2" (140)	5-3/8" (136)	Precision Ball	CS-04NRP-125-TL-TP01
4" (100)	1-1/4	Thermoplastic Rubber	190	5-1/2" (140)	5-3/8" (136)	Precision Ball	CS-04TPP-125-TL-TP01
4" (100)	1-1/4	Thermoplastic Rubber	190	5-1/2" (140)	5-3/8" (136)	Plain Bore	CS-04TPO-125-TL-TP01
4" (100)	1-1/4	Polyurethane TPU	190	5-1/2" (140)	5-3/8" (136)	Precision Ball	CS-04PYP-125-TL-TP01
5" (125)	1-1/4	Neoprene Rubber	220	6-1/2" (165)	5-3/8" (136)	Precision Ball	CS-05NRP-125-TL-TP01
5" (125)	1-1/4	Thermoplastic Rubber	220	6-1/2" (165)	5-3/8" (136)	Precision Ball	CS-05TPP-125-TL-TP01
5" (125)	1-1/4	Thermoplastic Rubber	220	6-1/2" (165)	5-3/8" (136)	Plain Bore	CS-05TPO-125-TL-TP01
5" (125)	1-1/4	Polyurethane TPU	220	6-1/2" (165)	5-3/8" (136)	Precision Ball	CS-05PYP-125-TL-TP01



"Brake" stamped on pedal.

SWIVEL TOP PLATE DIRECTION LOCK MODELS (SWIVEL ONLY)

Wheel Diameter inches (mm)	Tread Width (inches)	Wheel Description	Capacity (lbs)	Load Height inches (mm)	Swivel Radius inches (mm)	Wheel Bearing	Model Number
4" (100)	1-1/4	Neoprene Rubber	190	5-1/2" (140)	5-3/8" (136)	Precision Ball	CS-04NRP-125-DL-TP01
4" (100)	1-1/4	Thermoplastic Rubber	190	5-1/2" (140)	5-3/8" (136)	Precision Ball	CS-04TPP-125-DL-TP01
4" (100)	1-1/4	Thermoplastic Rubber	190	5-1/2" (140)	5-3/8" (136)	Plain Bore	CS-04TPO-125-DL-TP01
4" (100)	1-1/4	Polyurethane TPU	190	5-1/2" (140)	5-3/8" (136)	Precision Ball	CS-04PYP-125-DL-TP01
5" (125)	1-1/4	Neoprene Rubber	220	6-1/2" (165)	5-3/8" (136)	Precision Ball	CS-05NRP-125-DL-TP01
5" (125)	1-1/4	Thermoplastic Rubber	220	6-1/2" (165)	5-3/8" (136)	Precision Ball	CS-05TPP-125-DL-TP01
5" (125)	1-1/4	Thermoplastic Rubber	220	6-1/2" (165)	5-3/8" (136)	Plain Bore	CS-05TPO-125-DL-TP01
5" (125)	1-1/4	Polyurethane TPU	220	6-1/2" (165)	5-3/8" (136)	Precision Ball	CS-05PYP-125-DL-TP01



"Steer" stamped on pedal.

TOP PLATE FITTING

Swivel Top Plate Pattern

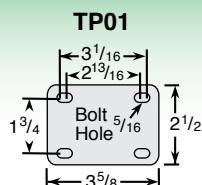

CHROME STEEL (CS)

HOLLOW KINGPIN MODELS
FREE SWIVEL • TOTAL LOCK • DIRECTION LOCK



- APPLICATIONS**
- Food Service
 - Case Carts
 - Utility Carts
 - Medical Equipment
 - Institutional Equipment
 - Hospital Carts
 - Pharmaceutical Equipment

- FEATURES**
- Dual Ball Swivel Raceways for added strength
 - Total Lock Brake models lock both swivel and wheel
 - Directional lock models lock swivel only (helps with Steering)
 - Wheels available with Precision ball bearings or spanner bushing
 - Wheels with Precision Bearings have Full Plastic thread guards for added protection
 - Bright Chrome Finish

Chrome Steel casters that look and meet the European standards.

HOLLOW KINGPIN MODELS

Wheel Diameter inches (mm)	Tread Width (inches)	Wheel Description	Capacity (Lbs)	Load Height inches (mm)	Swivel Radius inches (mm)	Wheel Bearing	Model Number
4" (100)	1-1/4	Neoprene Rubber	190	5-5/16" (135)	3-15/32" (88)	Precision Ball	CS-04NRP-125-SW-HKU1
4" (100)	1-1/4	Thermoplastic Rubber	190	5-5/16" (135)	3-15/32" (88)	Precision Ball	CS-04TPP-125-SW-HKU1
4" (100)	1-1/4	Thermoplastic Rubber	190	5-5/16" (135)	3-15/32" (88)	Plain Bore	CS-04TPO-125-SW-HKU1
4" (100)	1-1/4	Polyurethane TPU	190	5-5/16" (135)	3-15/32" (88)	Precision Ball	CS-04PYP-125-SW-HKU1
5" (125)	1-1/4	Neoprene Rubber	220	6-5/16" (160)	4-3/32" (104)	Precision Ball	CS-05NRP-125-SW-HKU1
5" (125)	1-1/4	Thermoplastic Rubber	220	6-5/16" (160)	4-3/32" (104)	Precision Ball	CS-05TPP-125-SW-HKU1
5" (125)	1-1/4	Thermoplastic Rubber	220	6-5/16" (160)	4-3/32" (104)	Plain Bore	CS-05TPO-125-SW-HKU1
5" (125)	1-1/4	Polyurethane TPU	220	6-5/16" (160)	4-3/32" (104)	Precision Ball	CS-05PYP-125-SW-HKU1



HOLLOW KINGPIN

Caster is provided unassembled to make it easy to add your choice of fitting. If you would like these assembled change HKU1 to HK01. 1/2 I.D.



CHROME STEEL (CS)

HOLLOW KINGPIN MODELS

FREE SWIVEL • TOTAL LOCK • DIRECTION LOCK

HOLLOW KINGPIN TOTAL LOCK MODELS (WHEEL AND SWIVEL)

Wheel Diameter inches (mm)	Tread Width (inches)	Wheel Description	Capacity (Lbs)	Load Height inches (mm)	Swivel Radius inches (mm)	Wheel Bearing	Model Number
4" (100)	1-1/4	Neoprene Rubber	190	5-5/16" (135)	5-3/8" (136)	Precision Ball	CS-04NRP-125-TL-HKU1
4" (100)	1-1/4	Thermoplastic Rubber	190	5-5/16" (135)	5-3/8" (136)	Precision Ball	CS-04TPP-125-TL-HKU1
4" (100)	1-1/4	Thermoplastic Rubber	190	5-5/16" (135)	5-3/8" (136)	Plain Bore	CS-04TPO-125-TL-HKU1
4" (100)	1-1/4	Polyurethane TPU	190	5-5/16" (135)	5-3/8" (136)	Precision Ball	CS-04PYP-125-TL-HKU1
5" (125)	1-1/4	Neoprene Rubber	220	6-5/16" (160)	5-3/8" (136)	Precision Ball	CS-05NRP-125-TL-HKU1
5" (125)	1-1/4	Thermoplastic Rubber	220	6-5/16" (160)	5-3/8" (136)	Precision Ball	CS-05TPP-125-TL-HKU1
5" (125)	1-1/4	Thermoplastic Rubber	220	6-5/16" (160)	5-3/8" (136)	Plain Bore	CS-05TPO-125-TL-HKU1
5" (125)	1-1/4	Polyurethane TPU	220	6-5/16" (160)	5-3/8" (136)	Precision Ball	CS-05PYP-125-TL-HKU1



"Brake" stamped on pedal.

HOLLOW KINGPIN DIRECTION LOCK MODELS (SWIVEL ONLY)

Wheel Diameter inches (mm)	Tread Width (inches)	Wheel Description	Capacity (Lbs)	Load Height inches (mm)	Swivel Radius inches (mm)	Wheel Bearing	Model Number
4" (100)	1-1/4	Neoprene Rubber	190	5-5/16" (135)	5-3/8" (136)	Precision Ball	CS-04NRP-125-DL-HKU1
4" (100)	1-1/4	Thermoplastic Rubber	190	5-5/16" (135)	5-3/8" (136)	Precision Ball	CS-04TPP-125-DL-HKU1
4" (100)	1-1/4	Thermoplastic Rubber	190	5-5/16" (135)	5-3/8" (136)	Plain Bore	CS-04TPO-125-DL-HKU1
4" (100)	1-1/4	Polyurethane TPU	190	5-5/16" (135)	5-3/8" (136)	Precision Ball	CS-04PYP-125-DL-HKU1
5" (125)	1-1/4	Neoprene Rubber	220	6-5/16" (160)	5-3/8" (136)	Precision Ball	CS-05NRP-125-DL-HKU1
5" (125)	1-1/4	Thermoplastic Rubber	220	6-5/16" (160)	5-3/8" (136)	Precision Ball	CS-05TPP-125-DL-HKU1
5" (125)	1-1/4	Thermoplastic Rubber	220	6-5/16" (160)	5-3/8" (136)	Plain Bore	CS-05TPO-125-DL-HKU1
5" (125)	1-1/4	Polyurethane TPU	220	6-5/16" (160)	5-3/8" (136)	Precision Ball	CS-05PYP-125-DL-HKU1



"Steer" stamped on pedal.

HOLLOW KINGPIN

Caster is provided unassembled to make it easy to add your choice of fitting. If you would like these assembled change HKU1 to HK01. 1/2 I.D.

CHROME STEEL (CS)

THREADED STEM MODELS

FREE SWIVEL • TOTAL LOCK • DIRECTION LOCK



- APPLICATIONS**
- Food Service
 - Case Carts
 - Utility Carts
 - Medical Equipment
 - Institutional Equipment
 - Hospital Carts
 - Pharmaceutical Equipment

- FEATURES**
- Dual Ball Swivel Raceways for added strength
 - Total Lock Brake models lock both swivel and wheel
 - Directional lock models lock swivel only (helps with Steering)
 - Wheels available with Precision ball bearings or spanner bushing
 - Wheels with Precision Bearings have Full Plastic thread guards for added protection
 - Bright Chrome Finish

Chrome Steel casters that look and meet the European standards.

THREADED STEM MODELS

Wheel Diameter inches (mm)	Tread Width (inches)	Wheel Description	Capacity (Lbs)	Load Height inches (mm)	Swivel Radius inches (mm)	Wheel Bearing	Model Number
4" (100)	1-1/4	Neoprene Rubber	190	5-5/16" (135)	3-15/32" (88)	Precision Ball	CS-04NRP-125-SW-
4" (100)	1-1/4	Thermoplastic Rubber	190	5-5/16" (135)	3-15/32" (88)	Precision Ball	CS-04TPP-125-SW-
4" (100)	1-1/4	Thermoplastic Rubber	190	5-5/16" (135)	3-15/32" (88)	Plain Bore	CS-04TPO-125-SW-
4" (100)	1-1/4	Polyurethane TPU	190	5-5/16" (135)	3-15/32" (88)	Precision Ball	CS-04PYP-125-SW-
5" (125)	1-1/4	Neoprene Rubber	220	6-5/16" (160)	4-3/32" (104)	Precision Ball	CS-05NRP-125-SW-
5" (125)	1-1/4	Thermoplastic Rubber	220	6-5/16" (160)	4-3/32" (104)	Precision Ball	CS-05TPP-125-SW-
5" (125)	1-1/4	Thermoplastic Rubber	220	6-5/16" (160)	4-3/32" (104)	Plain Bore	CS-05TPO-125-SW-
5" (125)	1-1/4	Polyurethane TPU	220	6-5/16" (160)	4-3/32" (104)	Precision Ball	CS-05PYP-125-SW-



Specify Threaded Stem (TS) code, see fittings below for dimensions.

THREADED STEM FITTINGS

Easy to install stem. See fittings page for more options.

TS02



TS03

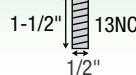

CHROME STEEL (CS)

THREADED STEM MODELS

FREE SWIVEL • TOTAL LOCK • DIRECTION LOCK

THREADED STEM TOTAL LOCK MODELS (WHEEL AND SWIVEL)

Wheel Diameter inches (mm)	Tread Width (inches)	Wheel Description	Capacity (Lbs)	Load Height inches (mm)	Swivel Radius inches (mm)	Wheel Bearing	Model Number
4" (100)	1-1/4	Neoprene Rubber	190	5-5/16" (135)	5-3/8" (136)	Precision Ball	CS-04NRP-125-TL-____
4" (100)	1-1/4	Thermoplastic Rubber	190	5-5/16" (135)	5-3/8" (136)	Precision Ball	CS-04TPP-125-TL-____
4" (100)	1-1/4	Thermoplastic Rubber	190	5-5/16" (135)	5-3/8" (136)	Plain Bore	CS-04TPO-125-TL-____
4" (100)	1-1/4	Polyurethane TPU	190	5-5/16" (135)	5-3/8" (136)	Precision Ball	CS-04PYP-125-TL-____
5" (125)	1-1/4	Neoprene Rubber	220	6-5/16" (160)	5-3/8" (136)	Precision Ball	CS-05NRP-125-TL-____
5" (125)	1-1/4	Thermoplastic Rubber	220	6-5/16" (160)	5-3/8" (136)	Precision Ball	CS-05TPP-125-TL-____
5" (125)	1-1/4	Thermoplastic Rubber	220	6-5/16" (160)	5-3/8" (136)	Plain Bore	CS-05TPO-125-TL-____
5" (125)	1-1/4	Polyurethane TPU	220	6-5/16" (160)	5-3/8" (136)	Precision Ball	CS-05PYP-125-TL-____



"Brake" stamped on pedal.

THREADED STEM DIRECTION LOCK MODELS (SWIVEL ONLY)

Wheel Diameter inches (mm)	Tread Width (inches)	Wheel Description	Capacity (Lbs)	Load Height inches (mm)	Swivel Radius inches (mm)	Wheel Bearing	Model Number
4" (100)	1-1/4	Neoprene Rubber	190	5-5/16" (135)	5-3/8" (136)	Precision Ball	CS-04NRP-125-DL-____
4" (100)	1-1/4	Thermoplastic Rubber	190	5-5/16" (135)	5-3/8" (136)	Precision Ball	CS-04TPP-125-DL-____
4" (100)	1-1/4	Thermoplastic Rubber	190	5-5/16" (135)	5-3/8" (136)	Plain Bore	CS-04TPO-125-DL-____
4" (100)	1-1/4	Polyurethane TPU	190	5-5/16" (135)	5-3/8" (136)	Precision Ball	CS-04PYP-125-DL-____
5" (125)	1-1/4	Neoprene Rubber	220	6-5/16" (160)	5-3/8" (136)	Precision Ball	CS-05NRP-125-DL-____
5" (125)	1-1/4	Thermoplastic Rubber	220	6-5/16" (160)	5-3/8" (136)	Precision Ball	CS-05TPP-125-DL-____
5" (125)	1-1/4	Thermoplastic Rubber	220	6-5/16" (160)	5-3/8" (136)	Plain Bore	CS-05TPO-125-DL-____
5" (125)	1-1/4	Polyurethane TPU	220	6-5/16" (160)	5-3/8" (136)	Precision Ball	CS-05PYP-125-DL-____



"Steer" stamped on pedal.

Specify Threaded Stem (TS) code, see fittings below for dimensions.

THREADED STEM FITTINGS

Easy to install stem. See fittings page for more options.

TS02



TS03

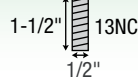

CHROME STEEL (CS)

GRIP RING STEM MODELS

FREE SWIVEL • TOTAL LOCK • DIRECTION LOCK



- APPLICATIONS**
- Food Service
 - Case Carts
 - Utility Carts
 - Medical Equipment
 - Institutional Equipment
 - Hospital Carts
 - Pharmaceutical Equipment

- FEATURES**
- Dual Ball Swivel Raceways for added strength
 - Total Lock Brake models lock both swivel and wheel
 - Directional lock models lock swivel only (helps with Steering)
 - Wheels available with Precision ball bearings or spanner bushing
 - Wheels with Precision Bearings have Full Plastic thread guards for added protection
 - Bright Chrome Finish

Chrome Steel casters that look and meet the European standards.

GRIP RING STEM MODELS

Wheel Diameter inches (mm)	Tread Width (inches)	Wheel Description	Capacity (Lbs)	Load Height inches (mm)	Swivel Radius inches (mm)	Wheel Bearing	Model Number
4" (100)	1-1/4	Neoprene Rubber	190	5-5/16" (135)	3-15/32" (88)	Precision Ball	CS-04NRP-125-SW-
4" (100)	1-1/4	Thermoplastic Rubber	190	5-5/16" (135)	3-15/32" (88)	Precision Ball	CS-04TPP-125-SW-
4" (100)	1-1/4	Thermoplastic Rubber	190	5-5/16" (135)	3-15/32" (88)	Plain Bore	CS-04TPO-125-SW-
4" (100)	1-1/4	Polyurethane TPU	190	5-5/16" (135)	3-15/32" (88)	Precision Ball	CS-04PYP-125-SW-
5" (125)	1-1/4	Neoprene Rubber	220	6-5/16" (160)	4-3/32" (104)	Precision Ball	CS-05NRP-125-SW-
5" (125)	1-1/4	Thermoplastic Rubber	220	6-5/16" (160)	4-3/32" (104)	Precision Ball	CS-05TPP-125-SW-
5" (125)	1-1/4	Thermoplastic Rubber	220	6-5/16" (160)	4-3/32" (104)	Plain Bore	CS-05TPO-125-SW-
5" (125)	1-1/4	Polyurethane TPU	220	6-5/16" (160)	4-3/32" (104)	Precision Ball	CS-05PYP-125-SW-



Specify Grip Ring Stem (GR) code, see fittings below for dimensions.

GRIP RING STEM FITTINGS

Easy to install grip rings snap into place. See fittings page for more options.

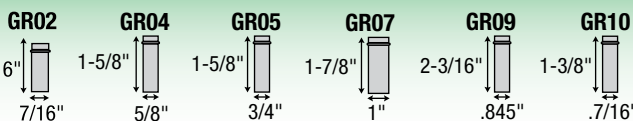

CHROME STEEL (CS)

GRIP RING STEM MODELS

FREE SWIVEL • TOTAL LOCK • DIRECTION LOCK

GRIP RING TOTAL LOCK MODELS (WHEEL AND SWIVEL)

Wheel Diameter inches (mm)	Tread Width (inches)	Wheel Description	Capacity (Lbs)	Load Height inches (mm)	Swivel Radius inches (mm)	Wheel Bearing	Model Number
4" (100)	1-1/4	Neoprene Rubber	190	5-5/16" (135)	5-3/8" (136)	Precision Ball	CS-04NRP-125-TL-___
4" (100)	1-1/4	Thermoplastic Rubber	190	5-5/16" (135)	5-3/8" (136)	Precision Ball	CS-04TPP-125-TL-___
4" (100)	1-1/4	Thermoplastic Rubber	190	5-5/16" (135)	5-3/8" (136)	Plain Bore	CS-04TPO-125-TL-___
4" (100)	1-1/4	Polyurethane TPU	190	5-5/16" (135)	5-3/8" (136)	Precision Ball	CS-04PYP-125-TL-___
5" (125)	1-1/4	Neoprene Rubber	220	6-5/16" (160)	5-3/8" (136)	Precision Ball	CS-05NRP-125-TL-___
5" (125)	1-1/4	Thermoplastic Rubber	220	6-5/16" (160)	5-3/8" (136)	Precision Ball	CS-05TPP-125-TL-___
5" (125)	1-1/4	Thermoplastic Rubber	220	6-5/16" (160)	5-3/8" (136)	Plain Bore	CS-05TPO-125-TL-___
5" (125)	1-1/4	Polyurethane TPU	220	6-5/16" (160)	5-3/8" (136)	Precision Ball	CS-05PYP-125-TL-___



"Brake" stamped on pedal.

GRIP RING DIRECTION LOCK MODELS (SWIVEL ONLY)

Wheel Diameter inches (mm)	Tread Width (inches)	Wheel Description	Capacity (Lbs)	Load Height inches (mm)	Swivel Radius inches (mm)	Wheel Bearing	Model Number
4" (100)	1-1/4	Neoprene Rubber	190	5-5/16" (135)	5-3/8" (136)	Precision Ball	CS-04NRP-125-DL-___
4" (100)	1-1/4	Thermoplastic Rubber	190	5-5/16" (135)	5-3/8" (136)	Precision Ball	CS-04TPP-125-DL-___
4" (100)	1-1/4	Thermoplastic Rubber	190	5-5/16" (135)	5-3/8" (136)	Plain Bore	CS-04TPO-125-DL-___
4" (100)	1-1/4	Polyurethane TPU	190	5-5/16" (135)	5-3/8" (136)	Precision Ball	CS-04PYP-125-DL-___
5" (125)	1-1/4	Neoprene Rubber	220	6-5/16" (160)	5-3/8" (136)	Precision Ball	CS-05NRP-125-DL-___
5" (125)	1-1/4	Thermoplastic Rubber	220	6-5/16" (160)	5-3/8" (136)	Precision Ball	CS-05TPP-125-DL-___
5" (125)	1-1/4	Thermoplastic Rubber	220	6-5/16" (160)	5-3/8" (136)	Plain Bore	CS-05TPO-125-DL-___
5" (125)	1-1/4	Polyurethane TPU	220	6-5/16" (160)	5-3/8" (136)	Precision Ball	CS-05PYP-125-DL-___



"Steer" stamped on pedal.

Specify Grip Ring Stem (GR) code, see fittings below for dimensions.

GRIP RING STEM FITTINGS

Easy to install grip rings snap into place. See fittings page for more options.

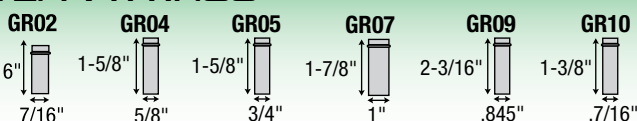

CHROME STEEL (CS)

ROUND/SQUARE STEM MODELS
FREE SWIVEL • TOTAL LOCK • DIRECTION LOCK



- APPLICATIONS**
- Food Service
 - Case Carts
 - Utility Carts
 - Medical Equipment
 - Institutional Equipment
 - Hospital Carts
 - Pharmaceutical Equipment

- FEATURES**
- Dual Ball Swivel Raceways for added strength
 - Total Lock Brake models lock both swivel and wheel
 - Directional lock models lock swivel only (helps with Steering)
 - Wheels available with Precision ball bearings or spanner bushing
 - Wheels with Precision Bearings have Full Plastic thread guards for added protection
 - Bright Chrome Finish

Chrome Steel casters that look and meet the European standards.

ROUND/SQUARE STEM MODELS

Wheel Diameter inches (mm)	Tread Width (inches)	Wheel Description	Capacity (Lbs)	Load Height inches (mm)	Swivel Radius inches (mm)	Wheel Bearing	Model Number
4" (100)	1-1/4	Neoprene Rubber	190	5-5/16" (135)	3-15/32" (88)	Precision Ball	CS-04NRP-125-SW-
4" (100)	1-1/4	Thermoplastic Rubber	190	5-5/16" (135)	3-15/32" (88)	Precision Ball	CS-04TPP-125-SW-
4" (100)	1-1/4	Thermoplastic Rubber	190	5-5/16" (135)	3-15/32" (88)	Plain Bore	CS-04TPO-125-SW-
4" (100)	1-1/4	Polyurethane TPU	190	5-5/16" (135)	3-15/32" (88)	Precision Ball	CS-04PYP-125-SW-
5" (125)	1-1/4	Neoprene Rubber	220	6-5/16" (160)	4-3/32" (104)	Precision Ball	CS-05NRP-125-SW-
5" (125)	1-1/4	Thermoplastic Rubber	220	6-5/16" (160)	4-3/32" (104)	Precision Ball	CS-05TPP-125-SW-
5" (125)	1-1/4	Thermoplastic Rubber	220	6-5/16" (160)	4-3/32" (104)	Plain Bore	CS-05TPO-125-SW-
5" (125)	1-1/4	Polyurethane TPU	220	6-5/16" (160)	4-3/32" (104)	Precision Ball	CS-05PYP-125-SW-



Specify Round Stem (RS) code, or Square Stem (SQ) code. See fittings below for dimensions.

ROUND STEM FITTINGS

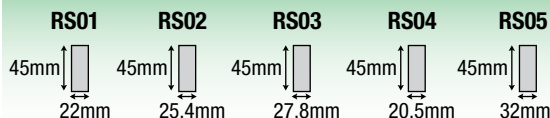

SQUARE STEM FITTINGS



See fittings page for more options.



CHROME STEEL (CS)

ROUND/SQUARE TOTAL LOCK MODELS (WHEEL AND SWIVEL)

Wheel Diameter inches (mm)	Tread Width (inches)	Wheel Description	Capacity (Lbs)	Load Height inches (mm)	Swivel Radius inches (mm)	Wheel Bearing	Model Number
4" (100)	1-1/4	Neoprene Rubber	190	5-5/16" (135)	5-3/8" (136)	Precision Ball	CS-04NRP-125-TL-___
4" (100)	1-1/4	Thermoplastic Rubber	190	5-5/16" (135)	5-3/8" (136)	Precision Ball	CS-04TPP-125-TL-___
4" (100)	1-1/4	Thermoplastic Rubber	190	5-5/16" (135)	5-3/8" (136)	Plain Bore	CS-04TPO-125-TL-___
4" (100)	1-1/4	Polyurethane TPU	190	5-5/16" (135)	5-3/8" (136)	Precision Ball	CS-04PYP-125-TL-___
5" (125)	1-1/4	Neoprene Rubber	220	6-5/16" (160)	5-3/8" (136)	Precision Ball	CS-05NRP-125-TL-___
5" (125)	1-1/4	Thermoplastic Rubber	220	6-5/16" (160)	5-3/8" (136)	Precision Ball	CS-05TPP-125-TL-___
5" (125)	1-1/4	Thermoplastic Rubber	220	6-5/16" (160)	5-3/8" (136)	Plain Bore	CS-05TPO-125-TL-___
5" (125)	1-1/4	Polyurethane TPU	220	6-5/16" (160)	5-3/8" (136)	Precision Ball	CS-05PYP-125-TL-___



"Brake" stamped on pedal.

ROUND/SQUARE DIRECTION LOCK MODELS (SWIVEL ONLY)

Wheel Diameter inches (mm)	Tread Width (inches)	Wheel Description	Capacity (Lbs)	Load Height inches (mm)	Swivel Radius inches (mm)	Wheel Bearing	Model Number
4" (100)	1-1/4	Neoprene Rubber	190	5-5/16" (135)	5-3/8" (136)	Precision Ball	CS-04NRP-125-DL-___
4" (100)	1-1/4	Thermoplastic Rubber	190	5-5/16" (135)	5-3/8" (136)	Precision Ball	CS-04TPP-125-DL-___
4" (100)	1-1/4	Thermoplastic Rubber	190	5-5/16" (135)	5-3/8" (136)	Plain Bore	CS-04TPO-125-DL-___
4" (100)	1-1/4	Polyurethane TPU	190	5-5/16" (135)	5-3/8" (136)	Precision Ball	CS-04PYP-125-DL-___
5" (125)	1-1/4	Neoprene Rubber	220	6-5/16" (160)	5-3/8" (136)	Precision Ball	CS-05NRP-125-DL-___
5" (125)	1-1/4	Thermoplastic Rubber	220	6-5/16" (160)	5-3/8" (136)	Precision Ball	CS-05TPP-125-DL-___
5" (125)	1-1/4	Thermoplastic Rubber	220	6-5/16" (160)	5-3/8" (136)	Plain Bore	CS-05TPO-125-DL-___
5" (125)	1-1/4	Polyurethane TPU	220	6-5/16" (160)	5-3/8" (136)	Precision Ball	CS-05PYP-125-DL-___



"Steer" stamped on pedal.

Specify Round Stem (RS) code, or Square Stem (SQ) code. See fittings below for dimensions.

ROUND STEM FITTINGS

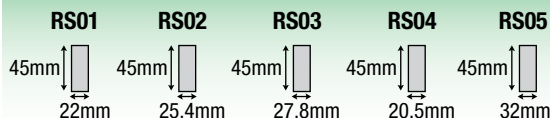

See fittings page for more options.

SQUARE STEM FITTINGS

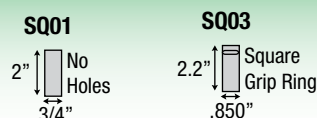

STAINLESS STEEL (SS)

TOP PLATE MODELS

FREE SWIVEL • TOTAL LOCK • DIRECTION LOCK
1-1/4 TREAD WIDTH



- APPLICATIONS**
- Food Service
 - Case Carts
 - Utility Carts
 - Medical Equipment
 - Institutional Equipment
 - Laboratory Equipment
 - Animal Cages
 - Pharmaceutical Equipment

- FEATURES**
- 304 Stainless Steel, Polished
 - Dual Ball Swivel Raceways for added strength
 - Total Lock Brake models lock both swivel and wheel
 - Directional lock models lock swivel only (helps with Steering)
 - Precision ball bearings in wheels for easier rollability
 - Wheels have full plastic thread guards for added protection
 - TPP and AMP wheels are crowned for easy rolling and turning

Our SS series design is constructed of stainless steel. This design gives you the quality necessary for most medical and pharmaceutical applications at an affordable price.

SWIVEL TOP PLATE MODELS

Wheel Diameter (Inches)	Tread Width (Inches)	Wheel Description	Capacity (Lbs)	Load Height Inches (mm)	Swivel Radius Inches (mm)	Wheel Bearing	Model Number
3	1-1/4	Conductive Rubber	165	4-7/16" (113)	2-29/32" (74)	Annular Ball	SS-03CRB-125-SW-___
3	1-1/4	Thermoplastic Rubber	165	4-7/16" (113)	2-29/32" (74)	Precision Ball	SS-03TPP-125-SW-___
3	1-1/4	Anti-Microbial TPR	165	4-7/16" (113)	2-29/32" (74)	Precision Ball	SS-03AMP-125-SW-___
3	1-1/4	Polyurethane TPU	165	4-7/16" (113)	2-29/32" (74)	Precision Ball	SS-03PYP-125-SW-___
4	1-1/4	Conductive Rubber	190	5-7/16" (138)	3-37/64" (91)	Annular Ball	SS-04CRB-125-SW-___
4	1-1/4	Thermoplastic Rubber	190	5-7/16" (138)	3-37/64" (91)	Precision Ball	SS-04TPP-125-SW-___
4	1-1/4	Anti-Microbial TPR	190	5-7/16" (138)	3-37/64" (91)	Precision Ball	SS-04AMP-125-SW-___
4	1-1/4	Polyurethane TPU	190	5-7/16" (138)	3-37/64" (91)	Precision Ball	SS-04PYP-125-SW-___
5	1-1/4	Conductive Rubber	220	6-7/16" (163)	4-7/32" (108)	Annular Ball	SS-05CRB-125-SW-___
5	1-1/4	Thermoplastic Rubber	220	6-7/16" (163)	4-7/32" (108)	Precision Ball	SS-05TPP-125-SW-___
5	1-1/4	Anti-Microbial TPR	220	6-7/16" (163)	4-7/32" (108)	Precision Ball	SS-05AMP-125-SW-___
5	1-1/4	Polyurethane TPU	220	6-7/16" (163)	4-7/32" (108)	Precision Ball	SS-05PYP-125-SW-___
6	1-1/4	Conductive Rubber	240	7-13/32" (188)	4-39/64 (117)	Annular Ball	SS-06CRB-125-SW-___
6	1-1/4	Thermoplastic Rubber	240	7-13/32" (188)	4-39/64 (117)	Precision Ball	SS-06TPP-125-SW-___
6	1-1/4	Anti-Microbial TPR	240	7-13/32" (188)	4-39/64 (117)	Precision Ball	SS-06AMP-125-SW-___
6	1-1/4	Polyurethane TPU	240	7-13/32" (188)	4-39/64 (117)	Precision Ball	SS-06PYP-125-SW-___



Rigid models available change "SW to "RG"

Specify Top Plate (TP___) code, see fittings at left for dimensions.

TOP PLATE FITTING

Swivel Top Plate Pattern

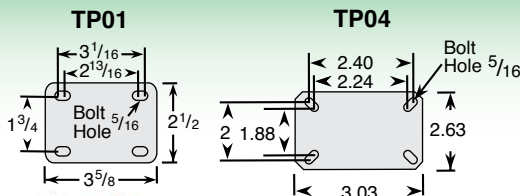

Anti-Microbial wheels have light green tread.



Stainless wheel bearings available. Change Bearing Code to "X" (Example : SS-03CRX-125-SW-___)

STAINLESS STEEL (SS)

SWIVEL TOP PLATE TOTAL LOCK MODELS (LOCKS WHEEL AND SWIVEL)

Wheel Diameter (Inches)	Tread Width (Inches)	Wheel Description	Capacity (Lbs)	Load Height Inches (mm)	Swivel Radius Inches (mm)	Wheel Bearing	Model Number
3	1-1/4	Conductive Rubber	165	4-7/16" (113)	4-1/4" (108)	Annular Ball	SS-03CRB-125-TL-__
3	1-1/4	Thermoplastic Rubber	165	4-7/16" (113)	4-1/4" (108)	Precision Ball	SS-03TPP-125-TL-__
3	1-1/4	Anti-Microbial TPR	165	4-7/16" (113)	4-1/4" (108)	Precision Ball	SS-03AMP-125-TL-__
3	1-1/4	Polyurethane TPU	165	4-7/16" (113)	4-1/4" (108)	Precision Ball	SS-03PYP-125-TL-__
4	1-1/4	Conductive Rubber	190	5-7/16" (138)	4-35/64" (115)	Annular Ball	SS-04CRB-125-TL-__
4	1-1/4	Thermoplastic Rubber	190	5-7/16" (138)	4-35/64" (115)	Precision Ball	SS-04TPP-125-TL-__
4	1-1/4	Anti-Microbial TPR	190	5-7/16" (138)	4-35/64" (115)	Precision Ball	SS-04AMP-125-TL-__
4	1-1/4	Polyurethane TPU	190	5-7/16" (138)	4-35/64" (115)	Precision Ball	SS-04PYP-125-TL-__
5	1-1/4	Conductive Rubber	220	6-7/16" (163)	4-55/64" (123)	Annular Ball	SS-05CRB-125-TL-__
5	1-1/4	Thermoplastic Rubber	220	6-7/16" (163)	4-55/64" (123)	Precision Ball	SS-05TPP-125-TL-__
5	1-1/4	Anti-Microbial TPR	220	6-7/16" (163)	4-55/64" (123)	Precision Ball	SS-05AMP-125-TL-__
5	1-1/4	Polyurethane TPU	220	6-7/16" (163)	4-55/64" (123)	Precision Ball	SS-05PYP-125-TL-__
6	1-1/4	Conductive Rubber	240	7-13/32" (188)	4-55/64" (123)	Annular Ball	SS-06CRB-125-TL-__
6	1-1/4	Thermoplastic Rubber	240	7-13/32" (188)	4-55/64" (123)	Precision Ball	SS-06TPP-125-TL-__
6	1-1/4	Anti-Microbial TPR	240	7-13/32" (188)	4-55/64" (123)	Precision Ball	SS-06AMP-125-TL-__
6	1-1/4	Polyurethane TPU	240	7-13/32" (188)	4-55/64" (123)	Precision Ball	SS-06PYP-125-TL-__



Total Lock
Change "SW"
to "TL". **Red**
sticker on pedal.

SWIVEL TOP PLATE DIRECTION LOCK MODELS (LOCKS SWIVEL ONLY)

Wheel Diameter (Inches)	Tread Width (Inches)	Wheel Description	Capacity (Lbs)	Load Height Inches (mm)	Swivel Radius Inches (mm)	Wheel Bearing	Model Number
3	1-1/4	Conductive Rubber	165	4-7/16" (113)	4-1/4" (108)	Annular Ball	SS-03CRB-125-DL-__
3	1-1/4	Thermoplastic Rubber	165	4-7/16" (113)	4-1/4" (108)	Precision Ball	SS-03TPP-125-DL-__
3	1-1/4	Anti-Microbial TPR	165	4-7/16" (113)	4-1/4" (108)	Precision Ball	SS-03AMP-125-DL-__
3	1-1/4	Polyurethane TPU	165	4-7/16" (113)	4-1/4" (108)	Precision Ball	SS-03PYP-125-DL-__
4	1-1/4	Conductive Rubber	190	5-7/16" (138)	4-35/64" (115)	Annular Ball	SS-04CRB-125-DL-__
4	1-1/4	Thermoplastic Rubber	190	5-7/16" (138)	4-35/64" (115)	Precision Ball	SS-04TPP-125-DL-__
4	1-1/4	Anti-Microbial TPR	190	5-7/16" (138)	4-35/64" (115)	Precision Ball	SS-04AMP-125-DL-__
4	1-1/4	Polyurethane TPU	190	5-7/16" (138)	4-35/64" (115)	Precision Ball	SS-04PYP-125-DL-__
5	1-1/4	Conductive Rubber	220	6-7/16" (163)	4-55/64" (123)	Annular Ball	SS-05CRB-125-DL-__
5	1-1/4	Thermoplastic Rubber	220	6-7/16" (163)	4-55/64" (123)	Precision Ball	SS-05TPP-125-DL-__
5	1-1/4	Anti-Microbial TPR	220	6-7/16" (163)	4-55/64" (123)	Precision Ball	SS-05AMP-125-DL-__
5	1-1/4	Polyurethane TPU	220	6-7/16" (163)	4-55/64" (123)	Precision Ball	SS-05PYP-125-DL-__
6	1-1/4	Conductive Rubber	240	7-13/32" (188)	4-55/64" (123)	Annular Ball	SS-06CRB-125-DL-__
6	1-1/4	Thermoplastic Rubber	240	7-13/32" (188)	4-55/64" (123)	Precision Ball	SS-06TPP-125-DL-__
6	1-1/4	Anti-Microbial TPR	240	7-13/32" (188)	4-55/64" (123)	Precision Ball	SS-06AMP-125-DL-__
6	1-1/4	Polyurethane TPU	240	7-13/32" (188)	4-55/64" (123)	Precision Ball	SS-06PYP-125-DL-__



Direction Lock
Change "SW"
to "DL". **Green**
sticker on pedal.

Specify Top Plate (TP__)
code, see fittings at left
for dimensions.

TOP PLATE FITTING

Swivel Top
Plate Pattern

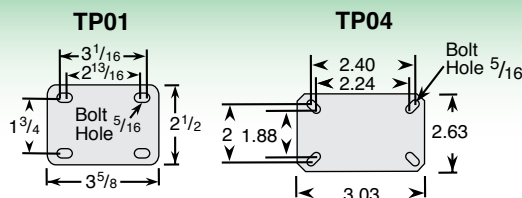

Stainless wheel bearings available. Change Bearing Code
to "X" (Example : SS-03CRX-125-SW-__)



STAINLESS STEEL (SS)

HOLLOW KINGPIN MODELS

FREE SWIVEL • TOTAL LOCK • DIRECTION LOCK
1-1/4 TREAD WIDTH



- APPLICATIONS**
- Food Service
 - Case Carts
 - Utility Carts
 - Medical Equipment
 - Institutional Equipment
 - Laboratory Equipment
 - Animal Cages
 - Pharmaceutical Equipment

- FEATURES**
- 304 Stainless Steel, Polished
 - Dual Ball Swivel Raceways for added strength
 - Total Lock Brake models lock both swivel and wheel
 - Directional lock models lock swivel only (helps with Steering)
 - Precision ball bearings in wheels for easier rollability
 - Wheels have full plastic thread guards for added protection
 - TPP and AMP wheels are crowned for easy rolling and turning

Our SS series design is constructed of stainless steel. This design gives you the quality necessary for most medical and pharmaceutical applications at an affordable price.

HOLLOW KINGPIN MODELS

Wheel Diameter (Inches)	Tread Width (Inches)	Wheel Description	Capacity (Lbs)	Load Height Inches (mm)	Swivel Radius Inches (mm)	Wheel Bearing	Model Number
3	1-1/4	Conductive Rubber	165	4-5/16" (109)	2-29/32" (74)	Annular Ball	SS-03CRB-125-SW-HKU1
3	1-1/4	Thermoplastic Rubber	165	4-5/16" (109)	2-29/32" (74)	Precision Ball	SS-03TPP-125-SW-HKU1
3	1-1/4	Anti-Microbial TPR	165	4-5/16" (109)	2-29/32" (74)	Precision Ball	SS-03AMP-125-SW-HKU1
3	1-1/4	Polyurethane TPU	165	4-5/16" (109)	2-29/32" (74)	Precision Ball	SS-03PYP-125-SW-HKU1
4	1-1/4	Conductive Rubber	165	5-5/16" (135)	3-37/64" (91)	Annular Ball	SS-04CRB-125-SW-HKU1
4	1-1/4	Thermoplastic Rubber	190	5-5/16" (135)	3-37/64" (91)	Precision Ball	SS-04TPP-125-SW-HKU1
4	1-1/4	Anti-Microbial TPR	190	5-5/16" (135)	3-37/64" (91)	Precision Ball	SS-04AMP-125-SW-HKU1
4	1-1/4	Polyurethane TPU	190	5-5/16" (135)	3-37/64" (91)	Precision Ball	SS-04PYP-125-SW-HKU1
5	1-1/4	Conductive Rubber	220	6-5/16" (160)	4-7/32" (108)	Annular Ball	SS-05CRB-125-SW-HKU1
5	1-1/4	Thermoplastic Rubber	220	6-5/16" (160)	4-7/32" (108)	Precision Ball	SS-05TPP-125-SW-HKU1
5	1-1/4	Anti-Microbial TPR	220	6-5/16" (160)	4-7/32" (108)	Precision Ball	SS-05AMP-125-SW-HKU1
5	1-1/4	Polyurethane TPU	220	6-5/16" (160)	4-7/32" (108)	Precision Ball	SS-05PYP-125-SW-HKU1
6	1-1/4	Conductive Rubber	240	7-9/32" (185)	4-39/64 (117)	Annular Ball	SS-06CRB-125-SW-HKU1
6	1-1/4	Thermoplastic Rubber	240	7-9/32" (185)	4-39/64 (117)	Precision Ball	SS-06TPP-125-SW-HKU1
6	1-1/4	Anti-Microbial TPR	240	7-9/32" (185)	4-39/64 (117)	Precision Ball	SS-06AMP-125-SW-HKU1
6	1-1/4	Polyurethane TPU	240	7-9/32" (185)	4-39/64 (117)	Precision Ball	SS-06PYP-125-SW-HKU1



HOLLOW KINGPIN

Caster is provided unassembled to make it easy to add your choice of fitting. If you would like these assembled change HKU1 to HKU1.1/2 I.D.

Anti-Microbial wheels have light green tread.

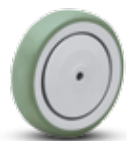

Stainless wheel bearings available. Change Bearing Code to "X" (Example : SS-03CRX-125-SW-___)



STAINLESS STEEL (SS)

HOLLOW KINGPIN TOTAL LOCK MODELS (LOCKS WHEEL AND SWIVEL)

Wheel Diameter (Inches)	Tread Width (Inches)	Wheel Description	Capacity (Lbs)	Load Height Inches (mm)	Swivel Radius Inches (mm)	Wheel Bearing	Model Number
3	1-1/4	Conductive Rubber	165	4-5/16" (109)	4-1/4" (108)	Precision Ball	SS-03CRB-125-TL-HKU1
3	1-1/4	Thermoplastic Rubber	165	4-5/16" (109)	4-1/4" (108)	Precision Ball	SS-03TPP-125-TL-HKU1
3	1-1/4	Anti-Microbial TPR	165	4-5/16" (109)	4-1/4" (108)	Precision Ball	SS-03AMP-125-TL-HKU1
3	1-1/4	Polyurethane TPU	165	4-5/16" (109)	4-1/4" (108)	Precision Ball	SS-03PYP-125-TL-HKU1
4	1-1/4	Conductive Rubber	190	5-5/16" (135)	4-35/64" (115)	Precision Ball	SS-04CRB-125-TL-HKU1
4	1-1/4	Thermoplastic Rubber	190	5-5/16" (135)	4-35/64" (115)	Precision Ball	SS-04TPP-125-TL-HKU1
4	1-1/4	Anti-Microbial TPR	190	5-5/16" (135)	4-35/64" (115)	Precision Ball	SS-04AMP-125-TL-HKU1
4	1-1/4	Polyurethane TPU	190	5-5/16" (135)	4-35/64" (115)	Precision Ball	SS-04PYP-125-TL-HKU1
5	1-1/4	Conductive Rubber	220	6-5/16" (160)	4-55/64" (123)	Precision Ball	SS-05CRB-125-TL-HKU1
5	1-1/4	Thermoplastic Rubber	220	6-5/16" (160)	4-55/64" (123)	Precision Ball	SS-05TPP-125-TL-HKU1
5	1-1/4	Anti-Microbial TPR	220	6-5/16" (160)	4-55/64" (123)	Precision Ball	SS-05AMP-125-TL-HKU1
5	1-1/4	Polyurethane TPU	220	6-5/16" (160)	4-55/64" (123)	Precision Ball	SS-05PYP-125-TL-HKU1
6	1-1/4	Conductive Rubber	240	7-9/32" (185)	4-55/64" (123)	Precision Ball	SS-06CRB-125-TL-HKU1
6	1-1/4	Thermoplastic Rubber	240	7-9/32" (185)	4-55/64" (123)	Precision Ball	SS-06TPP-125-TL-HKU1
6	1-1/4	Anti-Microbial TPR	240	7-9/32" (185)	4-55/64" (123)	Precision Ball	SS-06AMP-125-TL-HKU1
6	1-1/4	Polyurethane TPU	240	7-9/32" (185)	4-55/64" (123)	Precision Ball	SS-06PYP-125-TL-HKU1



Total Lock
Change "SW"
to "TL". Red
sticker on pedal.

HOLLOW KINGPIN DIRECTION LOCK MODELS (LOCKS SWIVEL ONLY)

Wheel Diameter (Inches)	Tread Width (Inches)	Wheel Description	Capacity (Lbs)	Load Height Inches (mm)	Swivel Radius Inches (mm)	Wheel Bearing	Model Number
3	1-1/4	Conductive Rubber	165	4-5/16" (109)	4-1/4" (108)	Precision Ball	SS-03CRB-125-DL-HKU1
3	1-1/4	Thermoplastic Rubber	165	4-5/16" (109)	4-1/4" (108)	Precision Ball	SS-03TPP-125-DL-HKU1
3	1-1/4	Anti-Microbial TPR	165	4-5/16" (109)	4-1/4" (108)	Precision Ball	SS-03AMP-125-DL-HKU1
3	1-1/4	Polyurethane TPU	165	4-5/16" (109)	4-1/4" (108)	Precision Ball	SS-03PYP-125-DL-HKU1
4	1-1/4	Conductive Rubber	190	5-5/16" (135)	4-35/64" (115)	Precision Ball	SS-04CRB-125-DL-HKU1
4	1-1/4	Thermoplastic Rubber	190	5-5/16" (135)	4-35/64" (115)	Precision Ball	SS-04TPP-125-DL-HKU1
4	1-1/4	Anti-Microbial TPR	190	5-5/16" (135)	4-35/64" (115)	Precision Ball	SS-04AMP-125-DL-HKU1
4	1-1/4	Polyurethane TPU	190	5-5/16" (135)	4-35/64" (115)	Precision Ball	SS-04PYP-125-DL-HKU1
5	1-1/4	Conductive Rubber	220	6-5/16" (160)	4-55/64" (123)	Precision Ball	SS-05CRB-125-DL-HKU1
5	1-1/4	Thermoplastic Rubber	220	6-5/16" (160)	4-55/64" (123)	Precision Ball	SS-05TPP-125-DL-HKU1
5	1-1/4	Anti-Microbial TPR	220	6-5/16" (160)	4-55/64" (123)	Precision Ball	SS-05AMP-125-DL-HKU1
5	1-1/4	Polyurethane TPU	220	6-5/16" (160)	4-55/64" (123)	Precision Ball	SS-05PYP-125-DL-HKU1
6	1-1/4	Conductive Rubber	240	7-9/32" (185)	4-55/64" (123)	Precision Ball	SS-06CRB-125-DL-HKU1
6	1-1/4	Thermoplastic Rubber	240	7-9/32" (185)	4-55/64" (123)	Precision Ball	SS-06TPP-125-DL-HKU1
6	1-1/4	Anti-Microbial TPR	240	7-9/32" (185)	4-55/64" (123)	Precision Ball	SS-06AMP-125-DL-HKU1
6	1-1/4	Polyurethane TPU	240	7-9/32" (185)	4-55/64" (123)	Precision Ball	SS-06PYP-125-DL-HKU1



Direction Lock
Change "SW"
to "DL". Green
sticker on pedal.

HOLLOW KINGPIN

Caster is provided unassembled to make it easy to add your choice of fitting. If you would like these assembled change HKU1 to HKU1.1/2 I.D.

Stainless wheel bearings available. Change Bearing Code to "X" (Example : SS-03CRX-125-SW-___)



STAINLESS STEEL (SS)

THREADED STEM MODELS

FREE SWIVEL • TOTAL LOCK • DIRECTION LOCK
1-1/4 TREAD WIDTH



- APPLICATIONS**
- Food Service
 - Case Carts
 - Utility Carts
 - Medical Equipment
 - Institutional Equipment
 - Laboratory Equipment
 - Animal Cages
 - Pharmaceutical Equipment

- FEATURES**
- 304 Stainless Steel, Polished
 - Dual Ball Swivel Raceways for added strength
 - Total Lock Brake models lock both swivel and wheel
 - Directional lock models lock swivel only (helps with Steering)
 - Precision ball bearings in wheels for easier rollability
 - Wheels have full plastic thread guards for added protection
 - TPP and AMP wheels are crowned for easy rolling and turning

Our SS series design is constructed of stainless steel. This design gives you the quality necessary for most medical and pharmaceutical applications at an affordable price.

THREADED STEM MODELS

Wheel Diameter (Inches)	Tread Width (Inches)	Wheel Description	Capacity (Lbs)	Load Height Inches (mm)	Swivel Radius Inches (mm)	Wheel Bearing	Model Number
3	1-1/4	Conductive Rubber	165	4-5/16" (109)	2-29/32" (74)	Annular Ball	SS-03CRB-125-SW-____
3	1-1/4	Thermoplastic Rubber	165	4-5/16" (109)	2-29/32" (74)	Precision Ball	SS-03TPP-125-SW-____
3	1-1/4	Anti-Microbial TPR	165	4-5/16" (109)	2-29/32" (74)	Precision Ball	SS-03AMP-125-SW-____
3	1-1/4	Polyurethane TPU	165	4-5/16" (109)	2-29/32" (74)	Precision Ball	SS-03PYP-125-SW-____
4	1-1/4	Conductive Rubber	165	5-5/16" (135)	3-37/64" (91)	Annular Ball	SS-04CRB-125-SW-____
4	1-1/4	Thermoplastic Rubber	190	5-5/16" (135)	3-37/64" (91)	Precision Ball	SS-04TPP-125-SW-____
4	1-1/4	Anti-Microbial TPR	190	5-5/16" (135)	3-37/64" (91)	Precision Ball	SS-04AMP-125-SW-____
4	1-1/4	Polyurethane TPU	190	5-5/16" (135)	3-37/64" (91)	Precision Ball	SS-04PYP-125-SW-____
5	1-1/4	Conductive Rubber	220	6-5/16" (160)	4-7/32" (108)	Annular Ball	SS-05CRB-125-SW-____
5	1-1/4	Thermoplastic Rubber	220	6-5/16" (160)	4-7/32" (108)	Precision Ball	SS-05TPP-125-SW-____
5	1-1/4	Anti-Microbial TPR	220	6-5/16" (160)	4-7/32" (108)	Precision Ball	SS-05AMP-125-SW-____
5	1-1/4	Polyurethane TPU	220	6-5/16" (160)	4-7/32" (108)	Precision Ball	SS-05PYP-125-SW-____
6	1-1/4	Conductive Rubber	240	7-9/32" (185)	4-39/64 (117)	Annular Ball	SS-06CRB-125-SW-____
6	1-1/4	Thermoplastic Rubber	240	7-9/32" (185)	4-39/64 (117)	Precision Ball	SS-06TPP-125-SW-____
6	1-1/4	Anti-Microbial TPR	240	7-9/32" (185)	4-39/64 (117)	Precision Ball	SS-06AMP-125-SW-____
6	1-1/4	Polyurethane TPU	240	7-9/32" (185)	4-39/64 (117)	Precision Ball	SS-06PYP-125-SW-____



Anti-Microbial wheels have light green tread.



THREADED STEM FITTINGS

See fittings page for more options.

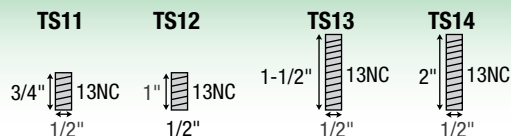

Specify Threaded Stem (TS) code, see fittings at left for dimensions.

Round and square stems available, please consult factory. Stainless wheel bearings available. Change Bearing Code to "X" (Example : SS-03CRX-125-SW-____)

STAINLESS STEEL (SS)

THREADED STEM TOTAL LOCK MODELS (LOCKS WHEEL AND SWIVEL)

Wheel Diameter (Inches)	Tread Width (Inches)	Wheel Description	Capacity (Lbs)	Load Height Inches (mm)	Swivel Radius Inches (mm)	Wheel Bearing	Model Number
3	1-1/4	Conductive Rubber	165	4-5/16" (109)	4-1/4" (108)	Precision Ball	SS-03CRB-125-TL-____
3	1-1/4	Thermoplastic Rubber	165	4-5/16" (109)	4-1/4" (108)	Precision Ball	SS-03TPP-125-TL-____
3	1-1/4	Anti-Microbial TPR	165	4-5/16" (109)	4-1/4" (108)	Precision Ball	SS-03AMP-125-TL-____
3	1-1/4	Polyurethane TPU	165	4-5/16" (109)	4-1/4" (108)	Precision Ball	SS-03PYP-125-TL-____
4	1-1/4	Conductive Rubber	190	5-5/16" (135)	4-35/64" (115)	Precision Ball	SS-04CRB-125-TL-____
4	1-1/4	Thermoplastic Rubber	190	5-5/16" (135)	4-35/64" (115)	Precision Ball	SS-04TPP-125-TL-____
4	1-1/4	Anti-Microbial TPR	190	5-5/16" (135)	4-35/64" (115)	Precision Ball	SS-04AMP-125-TL-____
4	1-1/4	Polyurethane TPU	190	5-5/16" (135)	4-35/64" (115)	Precision Ball	SS-04PYP-125-TL-____
5	1-1/4	Conductive Rubber	220	6-5/16" (160)	4-55/64" (123)	Precision Ball	SS-05CRB-125-TL-____
5	1-1/4	Thermoplastic Rubber	220	6-5/16" (160)	4-55/64" (123)	Precision Ball	SS-05TPP-125-TL-____
5	1-1/4	Anti-Microbial TPR	220	6-5/16" (160)	4-55/64" (123)	Precision Ball	SS-05AMP-125-TL-____
5	1-1/4	Polyurethane TPU	220	6-5/16" (160)	4-55/64" (123)	Precision Ball	SS-05PYP-125-TL-____
6	1-1/4	Conductive Rubber	240	7-9/32" (185)	4-55/64" (123)	Precision Ball	SS-06CRB-125-TL-____
6	1-1/4	Thermoplastic Rubber	240	7-9/32" (185)	4-55/64" (123)	Precision Ball	SS-06TPP-125-TL-____
6	1-1/4	Anti-Microbial TPR	240	7-9/32" (185)	4-55/64" (123)	Precision Ball	SS-06AMP-125-TL-____
6	1-1/4	Polyurethane TPU	240	7-9/32" (185)	4-55/64" (123)	Precision Ball	SS-06PYP-125-TL-____



Total Lock
Change "SW"
to "TL". Red
sticker on pedal.

THREADED STEM DIRECTION LOCK MODELS (LOCKS SWIVEL ONLY)

Wheel Diameter (Inches)	Tread Width (Inches)	Wheel Description	Capacity (Lbs)	Load Height Inches (mm)	Swivel Radius Inches (mm)	Wheel Bearing	Model Number
3	1-1/4	Conductive Rubber	165	4-5/16" (109)	4-1/4" (108)	Precision Ball	SS-03CRB-125-DL-____
3	1-1/4	Thermoplastic Rubber	165	4-5/16" (109)	4-1/4" (108)	Precision Ball	SS-03TPP-125-DL-____
3	1-1/4	Anti-Microbial TPR	165	4-5/16" (109)	4-1/4" (108)	Precision Ball	SS-03AMP-125-DL-____
3	1-1/4	Polyurethane TPU	165	4-5/16" (109)	4-1/4" (108)	Precision Ball	SS-03PYP-125-DL-____
4	1-1/4	Conductive Rubber	190	5-5/16" (135)	4-35/64" (115)	Precision Ball	SS-04CRB-125-DL-____
4	1-1/4	Thermoplastic Rubber	190	5-5/16" (135)	4-35/64" (115)	Precision Ball	SS-04TPP-125-DL-____
4	1-1/4	Anti-Microbial TPR	190	5-5/16" (135)	4-35/64" (115)	Precision Ball	SS-04AMP-125-DL-____
4	1-1/4	Polyurethane TPU	190	5-5/16" (135)	4-35/64" (115)	Precision Ball	SS-04PYP-125-DL-____
5	1-1/4	Conductive Rubber	220	6-5/16" (160)	4-55/64" (123)	Precision Ball	SS-05CRB-125-DL-____
5	1-1/4	Thermoplastic Rubber	220	6-5/16" (160)	4-55/64" (123)	Precision Ball	SS-05TPP-125-DL-____
5	1-1/4	Anti-Microbial TPR	220	6-5/16" (160)	4-55/64" (123)	Precision Ball	SS-05AMP-125-DL-____
5	1-1/4	Polyurethane TPU	220	6-5/16" (160)	4-55/64" (123)	Precision Ball	SS-05PYP-125-DL-____
6	1-1/4	Conductive Rubber	240	7-9/32" (185)	4-55/64" (123)	Precision Ball	SS-06CRB-125-DL-____
6	1-1/4	Thermoplastic Rubber	240	7-9/32" (185)	4-55/64" (123)	Precision Ball	SS-06TPP-125-DL-____
6	1-1/4	Anti-Microbial TPR	240	7-9/32" (185)	4-55/64" (123)	Precision Ball	SS-06AMP-125-DL-____
6	1-1/4	Polyurethane TPU	240	7-9/32" (185)	4-55/64" (123)	Precision Ball	SS-06PYP-125-DL-____



Direction Lock
Change "SW"
to "DL". Green
sticker on pedal.

THREADED STEM FITTINGS

See fittings page for more options.

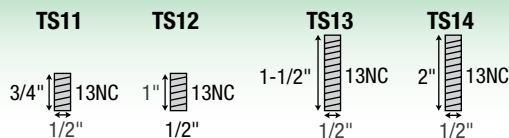

Round and square stems available, please consult factory.
Stainless wheel bearings available. Change Bearing Code
to "X" (Example : SS-03CRX-125-SW-____)

Specify Threaded
Stem (TS) code, see
fittings at left for
dimensions.

STAINLESS STEEL (SS)

TOP PLATE MODELS

FREE SWIVEL • TOTAL LOCK
2" TREAD WIDTH



New Total Lock brake design – locks both brake and swivel.

- APPLICATIONS**
- Food Service
 - Case Carts
 - Utility Carts
 - Medical Equipment
 - Institutional Equipment
 - Laboratory Equipment
 - Animal Cages
 - Pharmaceutical Equipment

- FEATURES**
- Fork legs, top plate and yoke base are made of 1/4" thick 304 polished stainless steel for added corrosion protection
 - Total Lock brake models lock both brake and swivel
 - Dual Ball Swivel Raceways for added strength
 - Swivel seals are standard for added protection
 - Stainless axles provided with grease fitting
 - Grease fitting in swivel raceway

Our SS series design is constructed of stainless steel. This design gives you the quality necessary for most medical and pharmaceutical applications at an affordable price.

TOP PLATE MODELS

Wheel Diameter (Inches)	Tread Width (Inches)	Wheel Description	Capacity (Lbs)	Load Height (Inches)	Swivel Radius (Inches)	Wheel Bearing	Model Number
4	2	Phenolic	800	5-5/8	3-3/8	Roller	SS-04PHR-200-SW-TP03
4	2	Phenolic	800	5-5/8	3-3/8	Delrin	SS-04PHD-200-SW-TP03
4	2	Nylon	800	5-5/8	3-3/8	Roller	SS-04NYR-200-SW-TP03
4	2	Nylon	800	5-5/8	3-3/8	Delrin	SS-04NYD-200-SW-TP03
4	2	Polyurethane Solid	800	5-5/8	3-3/8	Roller	SS-04PSR-200-SW-TP03
4	2	Polyurethane Solid	800	5-5/8	3-3/8	Delrin	SS-04PSD-200-SW-TP03
4	2	Polyolefin	800	5-5/8	3-3/8	Roller	SS-04PPR-200-SW-TP03
4	2	Polyolefin	800	5-5/8	3-3/8	Delrin	SS-04PPD-200-SW-TP03



Continues next page.

TOP PLATE FITTING

Swivel Top Plate Pattern

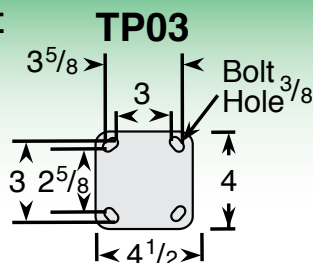

STAINLESS STEEL SIDE LOCK BRAKE

Wheel Diameter	Kit Number
4"	SS04200
5"	SS05200
6"	SS06200
8"	SS08200



To order field installable kit specify kit number. To order on caster change fork code from "SW" to "TB"

(Example: SS-06PSR-200-TB-TP03)

STAINLESS STEEL (SS)

TOP PLATE MODELS

FREE SWIVEL • TOTAL LOCK
2" TREAD WIDTH

Continues from previous page.

Wheel Diameter (Inches)	Tread Width (Inches)	Wheel Description	Capacity (Lbs)	Load Height (Inches)	Swivel Radius (Inches)	Wheel Bearing	Model Number
5	2	Phenolic	900	6-1/2	4-1/8	Roller	SS-05PHR-200-SW-TP03
5	2	Phenolic	900	6-1/2	4-1/8	Delrin	SS-05PHD-200-SW-TP03
5	2	Nylon	900	6-1/2	4-1/8	Roller	SS-05NYR-200-SW-TP03
5	2	Nylon	900	6-1/2	4-1/8	Delrin	SS-05NYD-200-SW-TP03
5	2	Polyurethane Solid	900	6-1/2	4-1/8	Roller	SS-05PSR-200-SW-TP03
5	2	Polyurethane Solid	900	6-1/2	4-1/8	Delrin	SS-05PSD-200-SW-TP03
5	2	Polyolefin	900	6-1/2	4-1/8	Roller	SS-05PPR-200-SW-TP03
5	2	Polyolefin	900	6-1/2	4-1/8	Delrin	SS-05PPD-200-SW-TP03
6	2	Phenolic	900	7-1/2	4-3/4	Roller	SS-06PHR-200-SW-TP03
6	2	Phenolic	900	7-1/2	4-3/4	Delrin	SS-06PHD-200-SW-TP03
6	2	Nylon	900	7-1/2	4-3/4	Roller	SS-06NYR-200-SW-TP03
6	2	Nylon	900	7-1/2	4-3/4	Delrin	SS-06NYD-200-SW-TP03
6	2	Polyurethane Solid	900	7-1/2	4-3/4	Roller	SS-06PSR-200-SW-TP03
6	2	Polyurethane Solid	900	7-1/2	4-3/4	Delrin	SS-06PSD-200-SW-TP03
6	2	Polyolefin	900	7-1/2	4-3/4	Roller	SS-06PPR-200-SW-TP03
6	2	Polyolefin	900	7-1/2	4-3/4	Delrin	SS-06PPD-200-SW-TP03
8	2	Phenolic	900	9-1/2	5-3/4	Roller	SS-08PHR-200-SW-TP03
8	2	Phenolic	900	9-1/2	5-3/4	Delrin	SS-08PHD-200-SW-TP03
8	2	Nylon	900	9-1/2	5-3/4	Roller	SS-08NYR-200-SW-TP03
8	2	Nylon	900	9-1/2	5-3/4	Delrin	SS-08NYD-200-SW-TP03
8	2	Polyurethane Solid	900	9-1/2	5-3/4	Roller	SS-08PSR-200-SW-TP03
8	2	Polyurethane Solid	900	9-1/2	5-3/4	Delrin	SS-08PSD-200-SW-TP03
8	2	Polyolefin	900	9-1/2	5-3/4	Roller	SS-08PPR-200-SW-TP03
8	2	Polyolefin	900	9-1/2	5-3/4	Delrin	SS-08PPD-200-SW-TP03



Stainless Steel Roller Bearings available, change bearing designation to S, example SS-08PHS200-SW-TP03.
Stainless Steel Precision Bearings available on some models, please consult factory.
Stainless wheel brakes are available for swivel models, Change SW to TB.
Rigid models are available, change SW to RG.

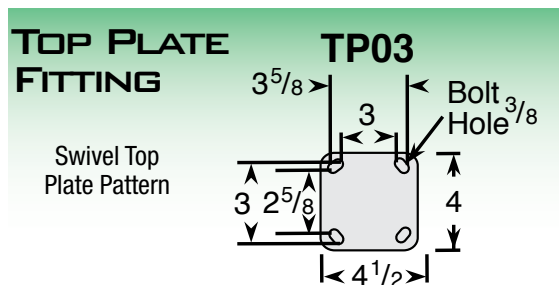

STAINLESS STEEL (SS)

TOP PLATE MODELS

FREE SWIVEL • TOTAL LOCK
2" TREAD WIDTH

TOP PLATE TOTAL LOCK MODELS

(LOCKS WHEEL AND SWIVEL)

Wheel Diameter (Inches)	Tread Width (Inches)	Wheel Description	Capacity (Lbs)	Load Height (Inches)	Swivel Radius (Inches)	Wheel Bearing	Model Number
4	2	Phenolic	800	5-5/8	3-3/8	Roller	SS-04PHR-200-TL-TP03
4	2	Phenolic	800	5-5/8	3-3/8	Delrin	SS-04PHD-200-TL-TP03
4	2	Nylon	800	5-5/8	3-3/8	Roller	SS-04NYR-200-TL-TP03
4	2	Nylon	800	5-5/8	3-3/8	Delrin	SS-04NYD-200-TL-TP03
4	2	Polyurethane Solid	800	5-5/8	3-3/8	Roller	SS-04PSR-200-TL-TP03
4	2	Polyurethane Solid	800	5-5/8	3-3/8	Delrin	SS-04PSD-200-TL-TP03
4	2	Polyolefin	800	5-5/8	3-3/8	Roller	SS-04PPR-200-TL-TP03
4	2	Polyolefin	800	5-5/8	3-3/8	Delrin	SS-04PPD-200-TL-TP03
5	2	Phenolic	900	6-1/2	4-1/8	Roller	SS-05PHR-200-TL-TP03
5	2	Phenolic	900	6-1/2	4-1/8	Delrin	SS-05PHD-200-TL-TP03
5	2	Nylon	900	6-1/2	4-1/8	Roller	SS-05NYR-200-TL-TP03
5	2	Nylon	900	6-1/2	4-1/8	Delrin	SS-05NYD-200-TL-TP03
5	2	Polyurethane Solid	900	6-1/2	4-1/8	Roller	SS-05PSR-200-TL-TP03
5	2	Polyurethane Solid	900	6-1/2	4-1/8	Delrin	SS-05PSD-200-TL-TP03
5	2	Polyolefin	900	6-1/2	4-1/8	Roller	SS-05PPR-200-TL-TP03
5	2	Polyolefin	900	6-1/2	4-1/8	Delrin	SS-05PPD-200-TL-TP03
6	2	Phenolic	900	7-1/2	4-3/4	Roller	SS-06PHR-200-TL-TP03
6	2	Phenolic	900	7-1/2	4-3/4	Delrin	SS-06PHD-200-TL-TP03
6	2	Nylon	900	7-1/2	4-3/4	Roller	SS-06NYR-200-TL-TP03
6	2	Nylon	900	7-1/2	4-3/4	Delrin	SS-06NYD-200-TL-TP03
6	2	Polyurethane Solid	900	7-1/2	4-3/4	Roller	SS-06PSR-200-TL-TP03
6	2	Polyurethane Solid	900	7-1/2	4-3/4	Delrin	SS-06PSD-200-TL-TP03
6	2	Polyolefin	900	7-1/2	4-3/4	Roller	SS-06PPR-200-TL-TP03
6	2	Polyolefin	900	7-1/2	4-3/4	Delrin	SS-06PPD-200-TL-TP03
8	2	Phenolic	900	9-1/2	5-3/4	Roller	SS-08PHR-200-TL-TP03
8	2	Phenolic	900	9-1/2	5-3/4	Delrin	SS-08PHD-200-TL-TP03
8	2	Nylon	900	9-1/2	5-3/4	Roller	SS-08NYR-200-TL-TP03
8	2	Nylon	900	9-1/2	5-3/4	Delrin	SS-08NYD-200-TL-TP03
8	2	Polyurethane Solid	900	9-1/2	5-3/4	Roller	SS-08PSR-200-TL-TP03
8	2	Polyurethane Solid	900	9-1/2	5-3/4	Delrin	SS-08PSD-200-TL-TP03
8	2	Polyolefin	900	9-1/2	5-3/4	Roller	SS-08PPR-200-TL-TP03
8	2	Polyolefin	900	9-1/2	5-3/4	Delrin	SS-08PPD-200-TL-TP03



"NG" Next Generation

NYLON CASTERS – THE INSIDE STORY



3" thru 6" wheel diameters available.

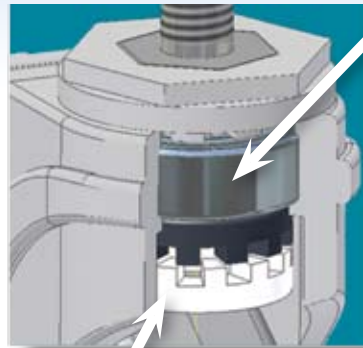

Direction and Total Lock braking action designed into caster.

NG series has precision sealed ball bearing raceway design for long lasting, smooth, quiet, maintenance free ride. Precision ball bearings are insert molded into the swivel raceway. Caster capacity is similar to steel wheels at a massive 325 lbs with 5" wheel.

PERFORMANCE FEATURES

- **QUIET**
- **CLEAN**
- **SMOOTH**
- **MAINTENANCE FREE**
- **HIGHER CAPACITY**

PERFORMANCE OPTIONS

- **304 STAINLESS STEEL FITTINGS AND COMPONENTS (NS SERIES)**
- **ANTI-STATIC MODELS (NA/PA MODELS)**
- **PREVENZ ANTI-MICROBIAL MODELS**



Custom Colors Available

Glass filled nylon for added strength and durability. Custom colors available.

Sealed precision bearing is insert molded into the swivel raceway.

Wheels feature sealed precision ball bearings to provide a smooth, quiet and maintenance free ride.

Recessed nut and bolt axles with covers allow for easy wheel replacement. Blue cover  is Nylon Plus stainless steel, yellow cover  is anti-static, and green cover  is antimicrobial.

Fully Integrated thread guards prevent the pick-up of string, sutures and foreign debris.

Caster is resistant to most chemicals. Excellent for wash down applications.

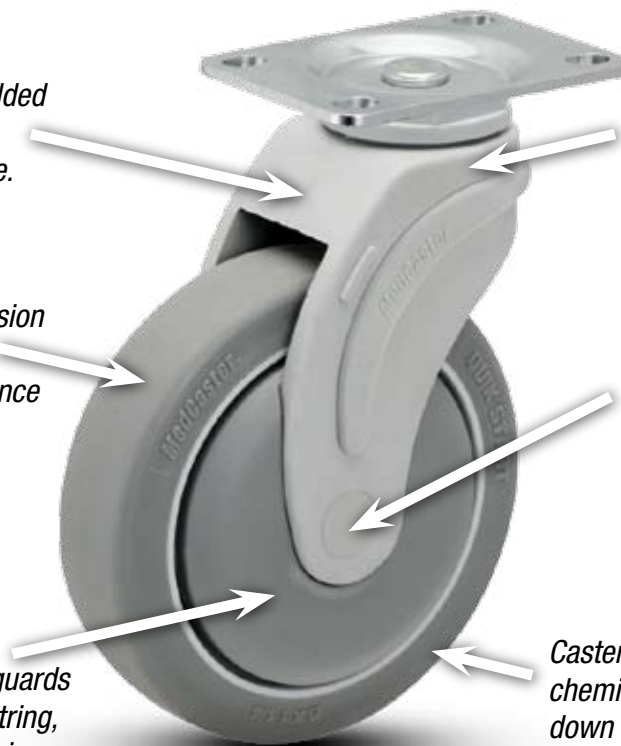

NEXT GENERATION NYLON (NG)

TOP PLATE MODELS

FREE SWIVEL • TOTAL LOCK • DIRECTION LOCK



- APPLICATIONS**
- Food Service Equipment
 - Case Carts
 - Utility Carts
 - Medical Equipment
 - Institutional Equipment
 - Hospital Carts
 - Animal Cage Carts

- FEATURES**
- Maintenance free
 - Sealed precision bearing raceway, smooth and quiet
 - Total Lock Brake models lock both swivel and wheel
 - Directional lock models lock swivel only (helps with steering)
 - Wheels feature sealed precision ball bearings and full thread guards
 - Resistance to most chemicals
 - Zinc plated top plate
 - Recessed axle with plastic cap covers



Custom Colors Available



Precision sealed ball bearing raceway design for smooth, quiet maintenance free ride.

Our NG series is made of glass filled nylon for added strength and durability. Precision ball bearings are insert molded into the swivel raceway.

SWIVEL TOP PLATE MODELS

Precision sealed ball bearing raceway design for smooth, quiet maintenance free ride.

Wheel Diameter (Inches)	Tread Width (Inches)	Wheel Description	Capacity (Lbs)	Load Height Inches (mm)	Swivel Radius Inches (mm)	Wheel Bearing	Model Number
3	1-1/4	QuikStart TPR	200	4-9/32" (109)	2-13/16" (72)	Precision Ball	NG-03QDP-125-SW-TP01
3	1-1/4	QuikStart TPR	200	4-9/32" (109)	2-13/16" (72)	Plain	NG-03QDO-125-SW-TP01
3	1-1/4	Anti-Microbial TPR	200	4-9/32" (109)	2-13/16" (72)	Precision Ball	NG-03AMP-125-SW-TP01
4	1-1/4	QuikStart TPR	275	5-9/16" (141)	3-1/2" (89)	Precision Ball	NG-04QDP-125-SW-TP01
4	1-1/4	Anti-Microbial TPR	275	5-9/16" (141)	3-1/2" (89)	Precision Ball	NG-04AMP-125-SW-TP01
5	1-1/4	QuikStart TPR	325	6-7/8" (174)	3-1/2" (89)	Precision Ball	NG-05QDP-125-SW-TP01
5	1-1/4	Anti-Microbial TPR	325	6-7/8" (174)	3-1/2" (89)	Precision Ball	NG-05AMP-125-SW-TP01
6	1-1/4	QuikStart TPR	325	7-11/16" (194)	4-5/8" (117)	Precision Ball	NG-06QDP-125-SW-TP01
6	1-1/4	QuikStart TPR	325	7-11/16" (194)	4-5/8" (117)	Plain	NG-06QDO-125-SW-TP01
6	1-1/4	Anti-Microbial TPR	325	7-11/16" (194)	4-5/8" (117)	Precision Ball	NG-06AMP-125-SW-TP01



Rigid model available for 5" and 6" diameter wheels. Change SW to RG.



Anti-Static models available!
Change Series code from "NG" to "NA".
Example: **NA-03QDP-125-SW-TP01**

TOP PLATE FITTING

Swivel Top Plate Pattern

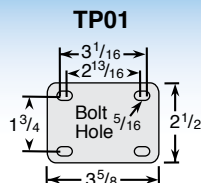

NEXT GENERATION NYLON (NG)

TOP PLATE MODELS

FREE SWIVEL • TOTAL LOCK • DIRECTION LOCK

SWIVEL TOP PLATE TOTAL LOCK MODELS

(LOCKS WHEEL AND SWIVEL)

Precision sealed ball bearing raceway design for smooth, quiet maintenance free ride.

Wheel Diameter (Inches)	Tread Width (Inches)	Wheel Description	Capacity (Lbs)	Load Height Inches (mm)	Swivel Radius Inches (mm)	Wheel Bearing	Model Number
3	1-1/4	QuikStart TPR	200	4-9/32" (109)	3-3/4" (96)	Precision Ball	NG-03QDP-125-TL-TP01
3	1-1/4	QuikStart TPR	200	4-9/32" (109)	3-3/4" (96)	Plain	NG-03QDO-125-TL-TP01
3	1-1/4	Anti-Microbial TPR	200	4-9/32" (109)	3-3/4" (96)	Precision Ball	NG-03AMP-125-TL-TP01
4	1-1/4	QuikStart TPR	275	5-9/16" (141)	4-15/16" (125)	Precision Ball	NG-04QDP-125-TL-TP01
4	1-1/4	Anti-Microbial TPR	275	5-9/16" (141)	4-15/16" (125)	Precision Ball	NG-04AMP-125-TL-TP01
5	1-1/4	QuikStart TPR	325	6-7/8" (174)	4-15/16" (125)	Precision Ball	NG-05QDP-125-TL-TP01
5	1-1/4	Anti-Microbial TPR	325	6-7/8" (174)	4-15/16" (125)	Precision Ball	NG-05AMP-125-TL-TP01
6	1-1/4	QuikStart TPR	325	7-11/16" (194)	4-5/8" (117)	Precision Ball	NG-06QDP-125-TL-TP01
6	1-1/4	QuikStart TPR	325	7-11/16" (194)	4-5/8" (117)	Plain	NG-06QDO-125-TL-TP01
6	1-1/4	Anti-Microbial TPR	325	7-11/16" (194)	4-5/8" (117)	Precision Ball	NG-06AMP-125-TL-TP01



SWIVEL TOP PLATE DIRECTION LOCK MODELS

(LOCKS SWIVEL ONLY)

Precision sealed ball bearing raceway design for smooth, quiet maintenance free ride.

Wheel Diameter (Inches)	Tread Width (Inches)	Wheel Description	Capacity (Lbs)	Load Height Inches (mm)	Swivel Radius Inches (mm)	Wheel Bearing	Model Number
3	1-1/4	QuikStart TPR	200	4-9/32" (109)	3-3/4" (96)	Precision Ball	NG-03QDP-125-DL-TP01
3	1-1/4	QuikStart TPR	200	4-9/32" (109)	3-3/4" (96)	Plain	NG-03QDO-125-DL-TP01
3	1-1/4	Anti-Microbial TPR	200	4-9/32" (109)	3-3/4" (96)	Precision Ball	NG-03AMP-125-DL-TP01
4	1-1/4	QuikStart TPR	275	5-9/16" (141)	4-15/16" (125)	Precision Ball	NG-04QDP-125-DL-TP01
4	1-1/4	Anti-Microbial TPR	275	5-9/16" (141)	4-15/16" (125)	Precision Ball	NG-04AMP-125-DL-TP01
5	1-1/4	QuikStart TPR	325	6-7/8" (174)	4-15/16" (125)	Precision Ball	NG-05QDP-125-DL-TP01
5	1-1/4	Anti-Microbial TPR	325	6-7/8" (174)	4-15/16" (125)	Precision Ball	NG-05AMP-125-DL-TP01
6	1-1/4	QuikStart TPR	325	7-11/16" (194)	4-5/8" (117)	Precision Ball	NG-06QDP-125-DL-TP01
6	1-1/4	QuikStart TPR	325	7-11/16" (194)	4-5/8" (117)	Plain	NG-06QDO-125-DL-TP01
6	1-1/4	Anti-Microbial TPR	325	7-11/16" (194)	4-5/8" (117)	Precision Ball	NG-06AMP-125-DL-TP01



Our Directional Lock casters are designed to lock the swivel but not the wheel allowing you to steer your equipment. The directional lock feature is designed to break free under heavier load when the unit is traversing a corner only to lock back into position when the unit resumes a straight course.

TOP PLATE FITTING

Swivel Top
Plate Pattern

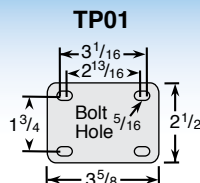

NEXT GENERATION NYLON (NG)

HOLLOW KINGPIN MODELS
FREE SWIVEL • TOTAL LOCK • DIRECTION LOCK



- APPLICATIONS**
- Food Service Equipment
 - Case Carts
 - Utility Carts
 - Medical Equipment
 - Institutional Equipment
 - Hospital Carts
 - Animal Cage Carts



Custom Colors Available



Precision sealed ball bearing raceway design for smooth, quiet maintenance free ride.

- FEATURES**
- Maintenance free
 - Sealed precision bearing raceway, smooth and quiet
 - Total Lock Brake models lock both swivel and wheel
 - Directional lock models lock swivel only (helps with steering)
 - Wheels feature sealed precision ball bearings and full thread guards
 - Resistance to most chemicals
 - Zinc plated top plate
 - Recessed axle with plastic cap covers

Our NG series is made of glass filled nylon for added strength and durability. Precision ball bearings are insert molded into the swivel raceway.

HOLLOW KINGPIN MODELS

Precision sealed ball bearing raceway design for smooth, quiet maintenance free ride.

Wheel Diameter (Inches)	Tread Width (Inches)	Wheel Description	Capacity (Lbs)	Load Height Inches (mm)	Swivel Radius Inches (mm)	Wheel Bearing	Model Number
3	1-1/4	QuikStart TPR	200	4-9/64" (105)	3-3/4" (95)	Precision Ball	NG-03QDP-125-SW-HKU1
3	1-1/4	QuikStart TPR	200	4-9/64" (105)	3-3/4" (95)	Plain	NG-03QDO-125-SW-HKU1
3	1-1/4	Anti-Microbial TPR	200	4-9/64" (105)	3-3/4" (95)	Precision Ball	NG-03AMP-125-SW-HKU1
4	1-1/4	QuikStart TPR	275	5-13/32" (137)	3-1/2" (89)	Precision Ball	NG-04QDP-125-SW-HKU1
4	1-1/4	Anti-Microbial TPR	275	5-13/32" (137)	3-1/2" (89)	Precision Ball	NG-04AMP-125-SW-HKU1
5	1-1/4	QuikStart TPR	325	6-1/2" (165)	3-1/2" (89)	Precision Ball	NG-05QDP-125-SW-HKU1
5	1-1/4	Anti-Microbial TPR	325	6-1/2" (165)	3-1/2" (89)	Precision Ball	NG-05AMP-125-SW-HKU1
6	1-1/4	QuikStart TPR	325	7-1/2" (191)	4-5/8" (117)	Precision Ball	NG-06QDP-125-SW-HKU1
6	1-1/4	QuikStart TPR	325	7-1/2" (191)	4-5/8" (117)	Plain	NG-06QDO-125-SW-HKU1
6	1-1/4	Anti-Microbial TPR	325	7-1/2" (191)	4-5/8" (117)	Precision Ball	NG-06AMP-125-SW-HKU1



Anti-Static models available!
Change Series code from "NG" to "NA".
Example: **NA-03QDP-125-SW-HKU1**

HOLLOW KINGPIN

Caster is provided unassembled to make it easy to add your choice of fitting. If you would like these assembled change HKU1 to HKO1. 3/8" I.D. on 3" diam. models; 1/2" I.D. on 4", 5", & 6" diam. models.



NEXT GENERATION NYLON (NG)

HOLLOW KINGPIN MODELS
FREE SWIVEL • TOTAL LOCK • DIRECTION LOCK

HOLLOW KINGPIN TOTAL LOCK MODELS (LOCKS WHEEL AND SWIVEL)

Precision sealed ball bearing raceway design for smooth, quiet maintenance free ride.

Wheel Diameter (Inches)	Tread Width (Inches)	Wheel Description	Capacity (lbs)	Load Height Inches (mm)	Swivel Radius Inches (mm)	Wheel Bearing	Model Number
3	1-1/4	QuikStart TPR	200	4-1/8" (105)	3-3/4" (96)	Precision Ball	NG-03QDP-125-TL-HKU1
3	1-1/4	QuikStart TPR	200	4-1/8" (105)	3-3/4" (96)	Plain	NG-03QDO-125-TL-HKU1
3	1-1/4	Anti-Microbial TPR	200	4-1/8" (105)	3-3/4" (96)	Precision Ball	NG-03AMP-125-TL-HKU1
4	1-1/4	QuikStart TPR	275	5-13/32" (137)	4-15/16" (125)	Precision Ball	NG-04QDP-125-TL-HKU1
4	1-1/4	Anti-Microbial TPR	275	5-13/32" (137)	4-15/16" (125)	Precision Ball	NG-04AMP-125-TL-HKU1
5	1-1/4	QuikStart TPR	325	6-1/2" (165)	4-15/16" (125)	Precision Ball	NG-05QDP-125-TL-HKU1
5	1-1/4	Anti-Microbial TPR	325	6-1/2" (165)	4-15/16" (125)	Precision Ball	NG-05AMP-125-TL-HKU1
6	1-1/4	QuikStart TPR	325	7-1/2" (191)	4-5/8" (117)	Precision Ball	NG-06QDP-125-TL-HKU1
6	1-1/4	QuikStart TPR	325	7-1/2" (191)	4-5/8" (117)	Plain	NG-06QDO-125-TL-HKU1
6	1-1/4	Anti-Microbial TPR	325	7-1/2" (191)	4-5/8" (117)	Precision Ball	NG-06AMP-125-TL-HKU1



HOLLOW KINGPIN DIRECTION LOCK MODELS (LOCKS SWIVEL ONLY)

Precision sealed ball bearing raceway design for smooth, quiet maintenance free ride.

Precision sealed ball bearing raceway design for smooth, quiet maintenance free ride.

Wheel Diameter (Inches)	Tread Width (Inches)	Wheel Description	Capacity (lbs)	Load Height Inches (mm)	Swivel Radius Inches (mm)	Wheel Bearing	Model Number
3	1-1/4	QuikStart TPR	200	4-1/8" (105)	3-3/4" (96)	Precision Ball	NG-03QDP-125-DL-HKU1
3	1-1/4	QuikStart TPR	200	4-1/8" (105)	3-3/4" (96)	Plain	NG-03QDO-125-DL-HKU1
3	1-1/4	Anti-Microbial TPR	200	4-1/8" (105)	3-3/4" (96)	Precision Ball	NG-03AMP-125-DL-HKU1
4	1-1/4	QuikStart TPR	275	5-13/32" (137)	4-15/16" (125)	Precision Ball	NG-04QDP-125-DL-HKU1
4	1-1/4	Anti-Microbial TPR	275	5-13/32" (137)	4-15/16" (125)	Precision Ball	NG-04AMP-125-DL-HKU1
5	1-1/4	QuikStart TPR	325	6-1/2" (165)	4-15/16" (125)	Precision Ball	NG-05QDP-125-DL-HKU1
5	1-1/4	Anti-Microbial TPR	325	6-1/2" (165)	4-15/16" (125)	Precision Ball	NG-05AMP-125-DL-HKU1
6	1-1/4	QuikStart TPR	325	7-1/2" (191)	4-5/8" (117)	Precision Ball	NG-06QDP-125-DL-HKU1
6	1-1/4	QuikStart TPR	325	7-1/2" (191)	4-5/8" (117)	Plain	NG-06QDO-125-DL-HKU1
6	1-1/4	Anti-Microbial TPR	325	7-1/2" (191)	4-5/8" (117)	Precision Ball	NG-06AMP-125-DL-HKU1



Our Directional Lock casters are designed to lock the swivel but not the wheel allowing you to steer your equipment. The directional lock feature is designed to break free under heavier load when the unit is traversing a corner only to lock back into position when the unit resumes a straight course.

HOLLOW KINGPIN

Caster is provided unassembled to make it easy to add your choice of fitting. If you would like these assembled change HKU1 to HKO1. 3/8" I.D. on 3" diam. models; 1/2" I.D. on 4", 5", & 6" diam. models.

NEXT GENERATION NYLON (NG)

GRIP RING STEM MODELS

FREE SWIVEL • TOTAL LOCK • DIRECTION LOCK



- APPLICATIONS**
- Food Service Equipment
 - Case Carts
 - Utility Carts
 - Medical Equipment
 - Institutional Equipment
 - Hospital Carts
 - Animal Cage Carts



Custom Colors Available



Precision sealed ball bearing raceway design for smooth, quiet maintenance free ride.

- FEATURES**
- Maintenance free
 - Sealed precision bearing raceway, smooth and quiet
 - Total Lock Brake models lock both swivel and wheel
 - Directional lock models lock swivel only (helps with steering)
 - Wheels feature sealed precision ball bearings and full thread guards
 - Resistance to most chemicals
 - Zinc plated top plate
 - Recessed axle with plastic cap covers

Our NG series is made of glass filled nylon for added strength and durability. Precision ball bearings are insert molded into the swivel raceway.

GRIP RING STEM MODELS

Precision sealed ball bearing raceway design for smooth, quiet maintenance free ride.

Wheel Diameter (Inches)	Tread Width (Inches)	Wheel Description	Capacity (Lbs)	Load Height Inches (mm)	Swivel Radius Inches (mm)	Wheel Bearing	Model Number
3	1-1/4	QuikStart TPR	200	4-9/64" (105)	3-3/4" (95)	Precision Ball	NG-03QDP-125-SW-___
3	1-1/4	QuikStart TPR	200	4-9/64" (105)	3-3/4" (95)	Plain	NG-03QDO-125-SW-___
3	1-1/4	Anti-Microbial TPR	200	4-9/64" (105)	3-3/4" (95)	Precision Ball	NG-03AMP-125-SW-___
4	1-1/4	QuikStart TPR	275	5-13/32" (137)	3-1/2" (89)	Precision Ball	NG-04QDP-125-SW-___
4	1-1/4	Anti-Microbial TPR	275	5-13/32" (137)	3-1/2" (89)	Precision Ball	NG-04AMP-125-SW-___
5	1-1/4	QuikStart TPR	325	6-1/2" (165)	3-1/2" (89)	Precision Ball	NG-05QDP-125-SW-___
5	1-1/4	Anti-Microbial TPR	325	6-1/2" (165)	3-1/2" (89)	Precision Ball	NG-05AMP-125-SW-___
6	1-1/4	QuikStart TPR	325	7-1/2" (191)	4-5/8" (117)	Precision Ball	NG-06QDP-125-SW-___
6	1-1/4	QuikStart TPR	325	7-1/2" (191)	4-5/8" (117)	Plain	NG-06QDO-125-SW-___
6	1-1/4	Anti-Microbial TPR	325	7-1/2" (191)	4-5/8" (117)	Precision Ball	NG-06AMP-125-SW-___



Anti-Static models available!
Change Series code from "NG" to "NA".
Example: **NA-03QDP-125-SW-GR02**

Specify Grip Ring Stem (GR) code, see fittings below for dimensions.

GRIP RING STEM FITTINGS

See fittings page for more options.

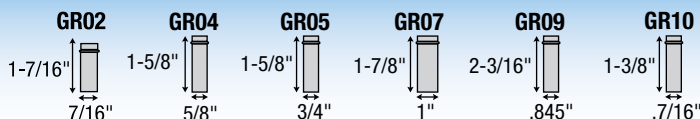

NEXT GENERATION NYLON (NG)

GRIP RING STEM MODELS
FREE SWIVEL • TOTAL LOCK • DIRECTION LOCK

GRIP RING STEM TOTAL LOCK MODELS

(LOCKS WHEEL AND SWIVEL)

Precision sealed ball bearing raceway design for smooth, quiet maintenance free ride.

Wheel Diameter (Inches)	Tread Width (Inches)	Wheel Description	Capacity (lbs)	Load Height Inches (mm)	Swivel Radius Inches (mm)	Wheel Bearing	Model Number
3	1-1/4	QuikStart TPR	200	4-1/8" (105)	3-3/4" (96)	Precision Ball	NG-03QDP-125-TL-___
3	1-1/4	QuikStart TPR	200	4-1/8" (105)	3-3/4" (96)	Plain	NG-03QDO-125-TL-___
3	1-1/4	Anti-Microbial TPR	200	4-1/8" (105)	3-3/4" (96)	Precision Ball	NG-03AMP-125-TL-___
4	1-1/4	QuikStart TPR	275	5-13/32" (137)	4-15/16" (125)	Precision Ball	NG-04QDP-125-TL-___
4	1-1/4	Anti-Microbial TPR	275	5-13/32" (137)	4-15/16" (125)	Precision Ball	NG-04AMP-125-TL-___
5	1-1/4	QuikStart TPR	325	6-1/2" (165)	4-15/16" (125)	Precision Ball	NG-05QDP-125-TL-___
5	1-1/4	Anti-Microbial TPR	325	6-1/2" (165)	4-15/16" (125)	Precision Ball	NG-05AMP-125-TL-___
6	1-1/4	QuikStart TPR	325	7-1/2" (191)	4-5/8" (117)	Precision Ball	NG-06QDP-125-TL-___
6	1-1/4	QuikStart TPR	325	7-1/2" (191)	4-5/8" (117)	Plain	NG-06QDO-125-TL-___
6	1-1/4	Anti-Microbial TPR	325	7-1/2" (191)	4-5/8" (117)	Precision Ball	NG-06AMP-125-TL-___



GRIP RING STEM DIRECTION LOCK MODELS

(LOCKS SWIVEL ONLY)

Precision sealed ball bearing raceway design for smooth, quiet maintenance free ride.

Wheel Diameter (Inches)	Tread Width (Inches)	Wheel Description	Capacity (lbs)	Load Height Inches (mm)	Swivel Radius Inches (mm)	Wheel Bearing	Model Number
3	1-1/4	QuikStart TPR	200	4-1/8" (105)	3-3/4" (96)	Precision Ball	NG-03QDP-125-DL-___
3	1-1/4	QuikStart TPR	200	4-1/8" (105)	3-3/4" (96)	Plain	NG-03QDO-125-DL-___
3	1-1/4	Anti-Microbial TPR	200	4-1/8" (105)	3-3/4" (96)	Precision Ball	NG-03AMP-125-DL-___
4	1-1/4	QuikStart TPR	275	5-13/32" (137)	4-15/16" (125)	Precision Ball	NG-04QDP-125-DL-___
4	1-1/4	Anti-Microbial TPR	275	5-13/32" (137)	4-15/16" (125)	Precision Ball	NG-04AMP-125-DL-___
5	1-1/4	QuikStart TPR	325	6-1/2" (165)	4-15/16" (125)	Precision Ball	NG-05QDP-125-DL-___
5	1-1/4	Anti-Microbial TPR	325	6-1/2" (165)	4-15/16" (125)	Precision Ball	NG-05AMP-125-DL-___
6	1-1/4	QuikStart TPR	325	7-1/2" (191)	4-5/8" (117)	Precision Ball	NG-06QDP-125-DL-___
6	1-1/4	QuikStart TPR	325	7-1/2" (191)	4-5/8" (117)	Plain	NG-06QDO-125-DL-___
6	1-1/4	Anti-Microbial TPR	325	7-1/2" (191)	4-5/8" (117)	Precision Ball	NG-06AMP-125-DL-___



Our Directional Lock casters are designed to lock the swivel but not the wheel allowing you to steer your equipment. The directional lock feature is designed to break free under heavier load when the unit is traversing a corner only to lock back into position when the unit resumes a straight course.

Specify Grip Ring Stem (GR) code, see fittings below for dimensions.

GRIP RING STEM FITTINGS

See fittings page for more options.

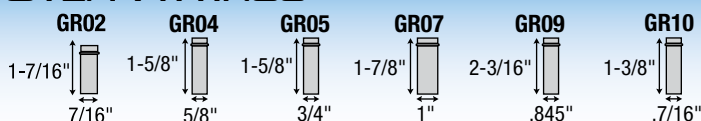

NEXT GENERATION NYLON (NG)

EXPANDING ADAPTER STEM MODELS
FREE SWIVEL • TOTAL LOCK • DIRECTION LOCK



- APPLICATIONS**
- Food Service Equipment
 - Case Carts
 - Utility Carts
 - Medical Equipment
 - Institutional Equipment
 - Hospital Carts
 - Animal Cage Carts



Custom Colors Available



Precision sealed ball bearing raceway design for smooth, quiet maintenance free ride.

- FEATURES**
- Maintenance free
 - Sealed precision bearing raceway, smooth and quiet
 - Total Lock Brake models lock both swivel and wheel
 - Directional lock models lock swivel only (helps with steering)
 - Wheels feature sealed precision ball bearings and full thread guards
 - Resistance to most chemicals
 - Zinc plated top plate
 - Recessed axle with plastic cap covers

Our NG series is made of glass filled nylon for added strength and durability. Precision ball bearings are insert molded into the swivel raceway.

EXPANDING ADAPTER STEM MODELS

Precision sealed ball bearing raceway design for smooth, quiet maintenance free ride.

Wheel Diameter (Inches)	Tread Width (Inches)	Wheel Description	Capacity (Lbs)	Load Height Inches (mm)	Swivel Radius Inches (mm)	Wheel Bearing	Model Number
3	1-1/4	QuikStart TPR	200	4-9/64" (105)	3-3/4" (95)	Precision Ball	NG-03QDP-125-SW-___
3	1-1/4	QuikStart TPR	200	4-9/64" (105)	3-3/4" (95)	Plain	NG-03QDO-125-SW-___
3	1-1/4	Anti-Microbial TPR	200	4-9/64" (105)	3-3/4" (95)	Precision Ball	NG-03AMP-125-SW-___
4	1-1/4	QuikStart TPR	275	5-13/32" (137)	3-1/2" (89)	Precision Ball	NG-04QDP-125-SW-___
4	1-1/4	Anti-Microbial TPR	275	5-13/32" (137)	3-1/2" (89)	Precision Ball	NG-04AMP-125-SW-___
5	1-1/4	QuikStart TPR	325	6-1/2" (165)	3-1/2" (89)	Precision Ball	NG-05QDP-125-SW-___
5	1-1/4	Anti-Microbial TPR	325	6-1/2" (165)	3-1/2" (89)	Precision Ball	NG-05AMP-125-SW-___
6	1-1/4	QuikStart TPR	325	7-1/2" (191)	4-5/8" (117)	Precision Ball	NG-06QDP-125-SW-___
6	1-1/4	QuikStart TPR	325	7-1/2" (191)	4-5/8" (117)	Plain	NG-06QDO-125-SW-___
6	1-1/4	Anti-Microbial TPR	325	7-1/2" (191)	4-5/8" (117)	Precision Ball	NG-06AMP-125-SW-___



Anti-Static models available!
Change Series code from "NG" to "NA".
Example: **NA-03QDP-125-SW-XRN1**

Specify Expanding Adapter Stem (XR) code, see fittings below for dimensions:

EXPANDING ADAPTER STEM FITTINGS

See fittings page for more options.



NEXT GENERATION NYLON (NG)

EXPANDING ADAPTER STEM MODELS
FREE SWIVEL • TOTAL LOCK • DIRECTION LOCK

EXPANDING ADAPTER STEM TOTAL LOCK MODELS (LOCKS WHEEL AND SWIVEL)

Precision sealed ball bearing raceway design for smooth, quiet maintenance free ride.

Wheel Diameter (Inches)	Tread Width (Inches)	Wheel Description	Capacity (Lbs)	Load Height Inches (mm)	Swivel Radius Inches (mm)	Wheel Bearing	Model Number
3	1-1/4	QuikStart TPR	200	4-1/8" (105)	3-3/4" (96)	Precision Ball	NG-03QDP-125-TL-__
3	1-1/4	QuikStart TPR	200	4-1/8" (105)	3-3/4" (96)	Plain	NG-03QDO-125-TL-__
3	1-1/4	Anti-Microbial TPR	200	4-1/8" (105)	3-3/4" (96)	Precision Ball	NG-03AMP-125-TL-__
4	1-1/4	QuikStart TPR	275	5-13/32" (137)	4-15/16" (125)	Precision Ball	NG-04QDP-125-TL-__
4	1-1/4	Anti-Microbial TPR	275	5-13/32" (137)	4-15/16" (125)	Precision Ball	NG-04AMP-125-TL-__
5	1-1/4	QuikStart TPR	325	6-1/2" (165)	4-15/16" (125)	Precision Ball	NG-05QDP-125-TL-__
5	1-1/4	Anti-Microbial TPR	325	6-1/2" (165)	4-15/16" (125)	Precision Ball	NG-05AMP-125-TL-__
6	1-1/4	QuikStart TPR	325	7-1/2" (191)	4-5/8" (117)	Precision Ball	NG-06QDP-125-TL-__
6	1-1/4	QuikStart TPR	325	7-1/2" (191)	4-5/8" (117)	Plain	NG-06QDO-125-TL-__
6	1-1/4	Anti-Microbial TPR	325	7-1/2" (191)	4-5/8" (117)	Precision Ball	NG-06AMP-125-TL-__



EXPANDING ADAPTER STEM DIRECTION LOCK MODELS (LOCKS SWIVEL ONLY)

Wheel Diameter (Inches)	Tread Width (Inches)	Wheel Description	Capacity (Lbs)	Load Height Inches (mm)	Swivel Radius Inches (mm)	Wheel Bearing	Model Number
3	1-1/4	QuikStart TPR	200	4-1/8" (105)	3-3/4" (96)	Precision Ball	NG-03QDP-125-DL-__
3	1-1/4	QuikStart TPR	200	4-1/8" (105)	3-3/4" (96)	Plain	NG-03QDO-125-DL-__
3	1-1/4	Anti-Microbial TPR	200	4-1/8" (105)	3-3/4" (96)	Precision Ball	NG-03AMP-125-DL-__
4	1-1/4	QuikStart TPR	275	5-13/32" (137)	4-15/16" (125)	Precision Ball	NG-04QDP-125-DL-__
4	1-1/4	Anti-Microbial TPR	275	5-13/32" (137)	4-15/16" (125)	Precision Ball	NG-04AMP-125-DL-__
5	1-1/4	QuikStart TPR	325	6-1/2" (165)	4-15/16" (125)	Precision Ball	NG-05QDP-125-DL-__
5	1-1/4	Anti-Microbial TPR	325	6-1/2" (165)	4-15/16" (125)	Precision Ball	NG-05AMP-125-DL-__
6	1-1/4	QuikStart TPR	325	7-1/2" (191)	4-5/8" (117)	Precision Ball	NG-06QDP-125-DL-__
6	1-1/4	QuikStart TPR	325	7-1/2" (191)	4-5/8" (117)	Plain	NG-06QDO-125-DL-__
6	1-1/4	Anti-Microbial TPR	325	7-1/2" (191)	4-5/8" (117)	Precision Ball	NG-06AMP-125-DL-__



Our Directional Lock casters are designed to lock the swivel but not the wheel allowing you to steer your equipment. The directional lock feature is designed to break free under heavier load when the unit is traversing a corner only to lock back into position when the unit resumes a straight course.

Specify Expanding Adapter Stem (XR) code, see fittings below for dimensions:

EXPANDING ADAPTER STEM FITTINGS

See fittings page for more options.



NEXT GENERATION NYLON (NG)

THREADED STEM MODELS
FREE SWIVEL • TOTAL LOCK • DIRECTION LOCK



- APPLICATIONS**
- Food Service Equipment
 - Case Carts
 - Utility Carts
 - Medical Equipment
 - Institutional Equipment
 - Hospital Carts
 - Animal Cage Carts

- FEATURES**
- Maintenance free
 - Sealed precision bearing raceway, smooth and quiet
 - Total Lock Brake models lock both swivel and wheel
 - Directional lock models lock swivel only (helps with steering)
 - Wheels feature sealed precision ball bearings and full thread guards
 - Resistance to most chemicals
 - Zinc plated top plate
 - Recessed axle with plastic cap covers



Custom Colors Available



Precision sealed ball bearing raceway design for smooth, quiet maintenance free ride.

Our NG series is made of glass filled nylon for added strength and durability. Precision ball bearings are insert molded into the swivel raceway.

THREADED STEM MODELS

Precision sealed ball bearing raceway design for smooth, quiet maintenance free ride.

Wheel Diameter (Inches)	Tread Width (Inches)	Wheel Description	Capacity (Lbs)	Load Height Inches (mm)	Swivel Radius Inches (mm)	Wheel Bearing	Model Number
3	1-1/4	QuikStart TPR	200	4-9/64" (105)	3-3/4" (95)	Precision Ball	NG-03QDP-125-SW-___
3	1-1/4	QuikStart TPR	200	4-9/64" (105)	3-3/4" (95)	Plain	NG-03QDO-125-SW-___
3	1-1/4	Anti-Microbial TPR	200	4-9/64" (105)	3-3/4" (95)	Precision Ball	NG-03AMP-125-SW-___
4	1-1/4	QuikStart TPR	275	5-13/32" (137)	3-1/2" (89)	Precision Ball	NG-04QDP-125-SW-___
4	1-1/4	Anti-Microbial TPR	275	5-13/32" (137)	3-1/2" (89)	Precision Ball	NG-04AMP-125-SW-___
5	1-1/4	QuikStart TPR	325	6-1/2" (165)	3-1/2" (89)	Precision Ball	NG-05QDP-125-SW-___
5	1-1/4	Anti-Microbial TPR	325	6-1/2" (165)	3-1/2" (89)	Precision Ball	NG-05AMP-125-SW-___
6	1-1/4	QuikStart TPR	325	7-1/2" (191)	4-5/8" (117)	Precision Ball	NG-06QDP-125-SW-___
6	1-1/4	QuikStart TPR	325	7-1/2" (191)	4-5/8" (117)	Plain	NG-06QDO-125-SW-___
6	1-1/4	Anti-Microbial TPR	325	7-1/2" (191)	4-5/8" (117)	Precision Ball	NG-06AMP-125-SW-___



Anti-Static models available!
Change Series code from "NG" to "NA".
Example: **NA-03QDP-125-SW-TS02**

Specify Threaded Stem (TS) code, see fittings below for dimensions:

THREADED STEM FITTINGS

See fittings page for more options.

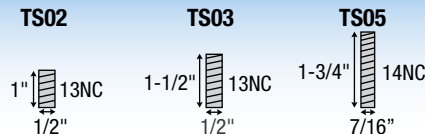

NEXT GENERATION NYLON (NG)

THREADED STEM MODELS

FREE SWIVEL • TOTAL LOCK • DIRECTION LOCK

THREADED STEM TOTAL LOCK MODELS (LOCKS WHEEL AND SWIVEL)

Wheel Diameter (Inches)	Tread Width (Inches)	Wheel Description	Capacity (Lbs)	Load Height Inches (mm)	Swivel Radius Inches (mm)	Wheel Bearing	Model Number
3	1-1/4	QuikStart TPR	200	4-1/8" (105)	3-3/4" (96)	Precision Ball	NG-03QDP-125-TL-___
3	1-1/4	QuikStart TPR	200	4-1/8" (105)	3-3/4" (96)	Plain	NG-03QDO-125-TL-___
3	1-1/4	Anti-Microbial TPR	200	4-1/8" (105)	3-3/4" (96)	Precision Ball	NG-03AMP-125-TL-___
4	1-1/4	QuikStart TPR	275	5-13/32" (137)	4-15/16" (125)	Precision Ball	NG-04QDP-125-TL-___
4	1-1/4	Anti-Microbial TPR	275	5-13/32" (137)	4-15/16" (125)	Precision Ball	NG-04AMP-125-TL-___
5	1-1/4	QuikStart TPR	325	6-1/2" (165)	4-15/16" (125)	Precision Ball	NG-05QDP-125-TL-___
5	1-1/4	Anti-Microbial TPR	325	6-1/2" (165)	4-15/16" (125)	Precision Ball	NG-05AMP-125-TL-___
6	1-1/4	QuikStart TPR	325	7-1/2" (191)	4-5/8" (117)	Precision Ball	NG-06QDP-125-TL-___
6	1-1/4	QuikStart TPR	325	7-1/2" (191)	4-5/8" (117)	Plain	NG-06QDO-125-TL-___
6	1-1/4	Anti-Microbial TPR	325	7-1/2" (191)	4-5/8" (117)	Precision Ball	NG-06AMP-125-TL-___



THREADED STEM DIRECTION LOCK MODELS (LOCKS SWIVEL ONLY)

Precision sealed ball bearing raceway design for smooth, quiet maintenance free ride.

Wheel Diameter (Inches)	Tread Width (Inches)	Wheel Description	Capacity (Lbs)	Load Height Inches (mm)	Swivel Radius Inches (mm)	Wheel Bearing	Model Number
3	1-1/4	QuikStart TPR	200	4-1/8" (105)	3-3/4" (96)	Precision Ball	NG-03QDP-125-DL-___
3	1-1/4	QuikStart TPR	200	4-1/8" (105)	3-3/4" (96)	Plain	NG-03QDO-125-DL-___
3	1-1/4	Anti-Microbial TPR	200	4-1/8" (105)	3-3/4" (96)	Precision Ball	NG-03AMP-125-DL-___
4	1-1/4	QuikStart TPR	275	5-13/32" (137)	4-15/16" (125)	Precision Ball	NG-04QDP-125-DL-___
4	1-1/4	Anti-Microbial TPR	275	5-13/32" (137)	4-15/16" (125)	Precision Ball	NG-04AMP-125-DL-___
5	1-1/4	QuikStart TPR	325	6-1/2" (165)	4-15/16" (125)	Precision Ball	NG-05QDP-125-DL-___
5	1-1/4	Anti-Microbial TPR	325	6-1/2" (165)	4-15/16" (125)	Precision Ball	NG-05AMP-125-DL-___
6	1-1/4	QuikStart TPR	325	7-1/2" (191)	4-5/8" (117)	Precision Ball	NG-06QDP-125-DL-___
6	1-1/4	QuikStart TPR	325	7-1/2" (191)	4-5/8" (117)	Plain	NG-06QDO-125-DL-___
6	1-1/4	Anti-Microbial TPR	325	7-1/2" (191)	4-5/8" (117)	Precision Ball	NG-06AMP-125-DL-___



Our Directional Lock casters are designed to lock the swivel but not the wheel allowing you to steer your equipment. The directional lock feature is designed to break free under heavier load when the unit is traversing a corner only to lock back into position when the unit resumes a straight course.

Specify Threaded Stem (TS) code, see fittings below for dimensions:

THREADED STEM FITTINGS

Easy to install stem. See fittings page for more options.

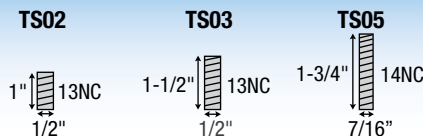

NEXT GENERATION NYLON (NG)

ROUND/SQUARE STEM MODELS
FREE SWIVEL • TOTAL LOCK • DIRECTION LOCK



- APPLICATIONS**
- Food Service Equipment
 - Case Carts
 - Utility Carts
 - Medical Equipment
 - Institutional Equipment
 - Hospital Carts
 - Animal Cage Carts



Custom Colors Available



Precision sealed ball bearing raceway design for smooth, quiet maintenance free ride.

- FEATURES**
- Maintenance free
 - Sealed precision bearing raceway, smooth and quiet
 - Total Lock Brake models lock both swivel and wheel
 - Directional lock models lock swivel only (helps with steering)
 - Wheels feature sealed precision ball bearings and full thread guards
 - Resistance to most chemicals
 - Zinc plated top plate
 - Recessed axle with plastic cap covers

Our NG series is made of glass filled nylon for added strength and durability. Precision ball bearings are insert molded into the swivel raceway.

ROUND OR SQUARE STEM MODELS

Precision sealed ball bearing raceway design for smooth, quiet maintenance free ride.

Wheel Diameter (Inches)	Tread Width (Inches)	Wheel Description	Capacity (Lbs)	Load Height Inches (mm)	Swivel Radius Inches (mm)	Wheel Bearing	Model Number
3	1-1/4	QuikStart TPR	200	4-9/64" (105)	3-3/4" (95)	Precision Ball	NG-03QDP-125-SW-__
3	1-1/4	QuikStart TPR	200	4-9/64" (105)	3-3/4" (95)	Plain	NG-03QDO-125-SW-__
3	1-1/4	Anti-Microbial TPR	200	4-9/64" (105)	3-3/4" (95)	Precision Ball	NG-03AMP-125-SW-__
4	1-1/4	QuikStart TPR	275	5-13/32" (137)	3-1/2" (89)	Precision Ball	NG-04QDP-125-SW-__
4	1-1/4	Anti-Microbial TPR	275	5-13/32" (137)	3-1/2" (89)	Precision Ball	NG-04AMP-125-SW-__
5	1-1/4	QuikStart TPR	325	6-1/2" (165)	3-1/2" (89)	Precision Ball	NG-05QDP-125-SW-__
5	1-1/4	Anti-Microbial TPR	325	6-1/2" (165)	3-1/2" (89)	Precision Ball	NG-05AMP-125-SW-__
6	1-1/4	QuikStart TPR	325	7-1/2" (191)	4-5/8" (117)	Precision Ball	NG-06QDP-125-SW-__
6	1-1/4	QuikStart TPR	325	7-1/2" (191)	4-5/8" (117)	Plain	NG-06QDO-125-SW-__
6	1-1/4	Anti-Microbial TPR	325	7-1/2" (191)	4-5/8" (117)	Precision Ball	NG-06AMP-125-SW-__



Anti-Static models available!
Change Series code from "NG" to "NA".
Example: **NA-03QDP-125-SW-SQ01**

Rigid model available for 5" and 6" diameter wheels. Change SW to RG.

ROUND STEM FITTINGS

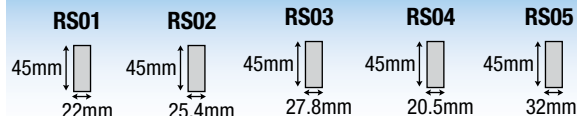

SQUARE STEM FITTINGS

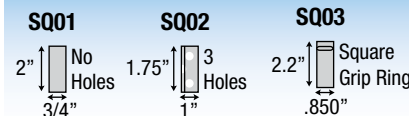

Specify Round Stem (RS) code, or Square Stem code (SQ) see fittings at left for dimensions.

See fittings page for more options.



NEXT GENERATION NYLON (NG)

ROUND/SQUARE STEM MODELS
FREE SWIVEL • TOTAL LOCK • DIRECTION LOCK

ROUND OR SQUARE STEM TOTAL LOCK MODELS (LOCKS WHEEL AND SWIVEL)

Wheel Diameter (Inches)	Tread Width (Inches)	Wheel Description	Capacity (Lbs)	Load Height Inches (mm)	Swivel Radius Inches (mm)	Wheel Bearing	Model Number
3	1-1/4	QuikStart TPR	200	4-1/8" (105)	3-3/4" (96)	Precision Ball	NG-03QDP-125-TL-__
3	1-1/4	QuikStart TPR	200	4-1/8" (105)	3-3/4" (96)	Plain	NG-03QDO-125-TL-__
3	1-1/4	Anti-Microbial TPR	200	4-1/8" (105)	3-3/4" (96)	Precision Ball	NG-03AMP-125-TL-__
4	1-1/4	QuikStart TPR	275	5-13/32" (137)	4-15/16" (125)	Precision Ball	NG-04QDP-125-TL-__
4	1-1/4	Anti-Microbial TPR	275	5-13/32" (137)	4-15/16" (125)	Precision Ball	NG-04AMP-125-TL-__
5	1-1/4	QuikStart TPR	325	6-1/2" (165)	4-15/16" (125)	Precision Ball	NG-05QDP-125-TL-__
5	1-1/4	Anti-Microbial TPR	325	6-1/2" (165)	4-15/16" (125)	Precision Ball	NG-05AMP-125-TL-__
6	1-1/4	QuikStart TPR	325	7-1/2" (191)	4-5/8" (117)	Precision Ball	NG-06QDP-125-TL-__
6	1-1/4	QuikStart TPR	325	7-1/2" (191)	4-5/8" (117)	Plain	NG-06QDO-125-TL-__
6	1-1/4	Anti-Microbial TPR	325	7-1/2" (191)	4-5/8" (117)	Precision Ball	NG-06AMP-125-TL-__



ROUND OR SQUARE STEM DIRECTION LOCK MODELS (LOCKS SWIVEL ONLY)

Precision sealed ball bearing raceway design for smooth, quiet maintenance free ride.

Wheel Diameter (Inches)	Tread Width (Inches)	Wheel Description	Capacity (Lbs)	Load Height Inches (mm)	Swivel Radius Inches (mm)	Wheel Bearing	Model Number
3	1-1/4	QuikStart TPR	200	4-1/8" (105)	3-3/4" (96)	Precision Ball	NG-03QDP-125-DL-__
3	1-1/4	QuikStart TPR	200	4-1/8" (105)	3-3/4" (96)	Plain	NG-03QDO-125-DL-__
3	1-1/4	Anti-Microbial TPR	200	4-1/8" (105)	3-3/4" (96)	Precision Ball	NG-03AMP-125-DL-__
4	1-1/4	QuikStart TPR	275	5-13/32" (137)	4-15/16" (125)	Precision Ball	NG-04QDP-125-DL-__
4	1-1/4	Anti-Microbial TPR	275	5-13/32" (137)	4-15/16" (125)	Precision Ball	NG-04AMP-125-DL-__
5	1-1/4	QuikStart TPR	325	6-1/2" (165)	4-15/16" (125)	Precision Ball	NG-05QDP-125-DL-__
5	1-1/4	Anti-Microbial TPR	325	6-1/2" (165)	4-15/16" (125)	Precision Ball	NG-05AMP-125-DL-__
6	1-1/4	QuikStart TPR	325	7-1/2" (191)	4-5/8" (117)	Precision Ball	NG-06QDP-125-DL-__
6	1-1/4	QuikStart TPR	325	7-1/2" (191)	4-5/8" (117)	Plain	NG-06QDO-125-DL-__
6	1-1/4	Anti-Microbial TPR	325	7-1/2" (191)	4-5/8" (117)	Precision Ball	NG-06AMP-125-DL-__



Our Directional Lock casters are designed to lock the swivel but not the wheel allowing you to steer your equipment. The directional lock feature is designed to break free under heavier load when the unit is traversing a corner only to lock back into position when the unit resumes a straight course.

ROUND STEM FITTINGS

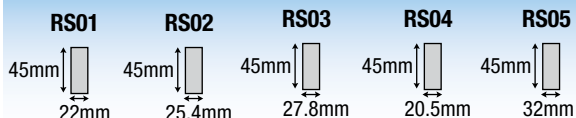

SQUARE STEM FITTINGS

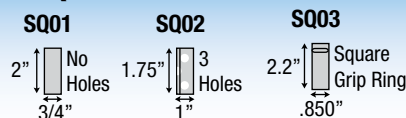

NYLON PLUS STAINLESS (NS)

TOP PLATE MODELS

FREE SWIVEL • TOTAL LOCK • DIRECTION LOCK



- APPLICATIONS**
- Food Service Equipment
 - Case Carts
 - Utility Carts
 - Medical Equipment
 - Institutional Equipment
 - Hospital Carts
 - Animal Cage Carts
 - Pharmaceutical Equipment

304 Stainless steel top plate and components!



Precision sealed ball bearing raceway design for smooth, quiet maintenance free ride.

- FEATURES**
- Sealed stainless steel precision bearing raceway, smooth and quiet
 - Total lock and direction lock brake models available
 - Wheels feature sealed stainless precision ball bearings and full thread guards
 - Resistant to most chemicals
 - Recessed Stainless axle with plastic cap covers
 - Maintenance free, requires no lubrication for rig or wheel

Our NS Series is similar to NG Series but with the added benefit of 304 stainless components making it excellent for wet environments.

SWIVEL TOP PLATE MODELS

Precision sealed ball bearing raceway design for smooth, quiet maintenance free ride.

Wheel Diameter (Inches)	Tread Width (Inches)	Wheel Description	Capacity (Lbs)	Load Height Inches (mm)	Swivel Radius Inches (mm)	Wheel Bearing	Model Number
3	1-1/4	QuikStart TPR	200	4-9/32" (109)	2-13/16" (72)	Precision Ball	NS-03QDP-125-SW-TP01
3	1-1/4	QuikStart TPR	200	4-9/32" (109)	2-13/16" (72)	Plain	NS-03QDO-125-SW-TP01
3	1-1/4	Anti-Microbial TPR	200	4-9/32" (109)	2-13/16" (72)	Precision Ball	NS-03AMP-125-SW-TP01
4	1-1/4	QuikStart TPR	275	5-9/16" (141)	3-1/2" (89)	Precision Ball	NS-04QDP-125-SW-TP01
4	1-1/4	Anti-Microbial TPR	275	5-9/16" (141)	3-1/2" (89)	Precision Ball	NS-04AMP-125-SW-TP01
5	1-1/4	QuikStart TPR	325	6-7/8" (174)	3-1/2" (89)	Precision Ball	NS-05QDP-125-SW-TP01
5	1-1/4	Anti-Microbial TPR	325	6-7/8" (174)	3-1/2" (89)	Precision Ball	NS-05AMP-125-SW-TP01
6	1-1/4	QuikStart TPR	325	7-11/16" (194)	4-5/8" (117)	Precision Ball	NS-06QDP-125-SW-TP01
6	1-1/4	QuikStart TPR	325	7-11/16" (194)	4-5/8" (117)	Plain	NS-06QDO-125-SW-TP01
6	1-1/4	Anti-Microbial TPR	325	7-11/16" (194)	4-5/8" (117)	Precision Ball	NS-06AMP-125-SW-TP01



316SS fittings available for non-magnetic applications. Consult factory.

Rigid model available for 5" and 6" diameter wheels. Change SW to RG.

TOP PLATE FITTING

Swivel Top Plate Pattern

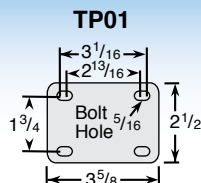

Custom Colors Available

NYLON PLUS STAINLESS (NS)

TOP PLATE MODELS

FREE SWIVEL • TOTAL LOCK • DIRECTION LOCK

SWIVEL TOP PLATE TOTAL LOCK MODELS

(LOCKS WHEEL AND SWIVEL)

Precision sealed ball bearing raceway design for smooth, quiet maintenance free ride.

Wheel Diameter (Inches)	Tread Width (Inches)	Wheel Description	Capacity (Lbs)	Load Height Inches (mm)	Swivel Radius Inches (mm)	Wheel Bearing	Model Number
3	1-1/4	QuikStart TPR	200	4-9/32" (109)	3-3/4" (96)	Precision Ball	NS-03QDP-125-TL-TP01
3	1-1/4	QuikStart TPR	200	4-9/32" (109)	3-3/4" (96)	Plain	NS-03QDO-125-TL-TP01
3	1-1/4	Anti-Microbial TPR	200	4-9/32" (109)	3-3/4" (96)	Precision Ball	NS-03AMP-125-TL-TP01
4	1-1/4	QuikStart TPR	275	5-9/16" (141)	4-15/16" (125)	Precision Ball	NS-04QDP-125-TL-TP01
4	1-1/4	Anti-Microbial TPR	275	5-9/16" (141)	4-15/16" (125)	Precision Ball	NS-04AMP-125-TL-TP01
5	1-1/4	QuikStart TPR	325	6-7/8" (174)	4-15/16" (125)	Precision Ball	NS-05QDP-125-TL-TP01
5	1-1/4	Anti-Microbial TPR	325	6-7/8" (174)	4-15/16" (125)	Precision Ball	NS-05AMP-125-TL-TP01
6	1-1/4	QuikStart TPR	325	7-11/16" (194)	4-5/8" (117)	Precision Ball	NS-06QDP-125-TL-TP01
6	1-1/4	QuikStart TPR	325	7-11/16" (194)	4-5/8" (117)	Plain	NS-06QDO-125-TL-TP01
6	1-1/4	Anti-Microbial TPR	325	7-11/16" (194)	4-5/8" (117)	Precision Ball	NS-06AMP-125-TL-TP01



SWIVEL TOP PLATE DIRECTION LOCK MODELS

(LOCKS SWIVEL ONLY)

Precision sealed ball bearing raceway design for smooth, quiet maintenance free ride.

Wheel Diameter (Inches)	Tread Width (Inches)	Wheel Description	Capacity (Lbs)	Load Height Inches (mm)	Swivel Radius Inches (mm)	Wheel Bearing	Model Number
3	1-1/4	QuikStart TPR	200	4-9/32" (109)	3-3/4" (96)	Precision Ball	NS-03QDP-125-DL-TP01
3	1-1/4	QuikStart TPR	200	4-9/32" (109)	3-3/4" (96)	Plain	NS-03QDO-125-DL-TP01
3	1-1/4	Anti-Microbial TPR	200	4-9/32" (109)	3-3/4" (96)	Precision Ball	NS-03AMP-125-DL-TP01
4	1-1/4	QuikStart TPR	275	5-9/16" (141)	4-15/16" (125)	Precision Ball	NS-04QDP-125-DL-TP01
4	1-1/4	Anti-Microbial TPR	275	5-9/16" (141)	4-15/16" (125)	Precision Ball	NS-04AMP-125-DL-TP01
5	1-1/4	QuikStart TPR	325	6-7/8" (174)	4-15/16" (125)	Precision Ball	NS-05QDP-125-DL-TP01
5	1-1/4	Anti-Microbial TPR	325	6-7/8" (174)	4-15/16" (125)	Precision Ball	NS-05AMP-125-DL-TP01
6	1-1/4	QuikStart TPR	325	7-11/16" (194)	4-5/8" (117)	Precision Ball	NS-06QDP-125-DL-TP01
6	1-1/4	QuikStart TPR	325	7-11/16" (194)	4-5/8" (117)	Plain	NS-06QDO-125-DL-TP01
6	1-1/4	Anti-Microbial TPR	325	7-11/16" (194)	4-5/8" (117)	Precision Ball	NS-06AMP-125-DL-TP01



Our Directional Lock casters are designed to lock the swivel but not the wheel allowing you to steer your equipment. The directional lock feature is designed to break free under heavier load when the unit is traversing a corner only to lock back into position when the unit resumes a straight course.

TOP PLATE FITTING

Swivel Top
Plate Pattern

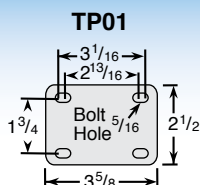

NYLON PLUS STAINLESS (NS)

HOLLOW KINGPIN MODELS
FREE SWIVEL • TOTAL LOCK • DIRECTION LOCK



- APPLICATIONS**
- Food Service Equipment
 - Case Carts
 - Utility Carts
 - Medical Equipment
 - Institutional Equipment
 - Hospital Carts
 - Animal Cage Carts
 - Pharmaceutical Equipment

304 Stainless steel components!

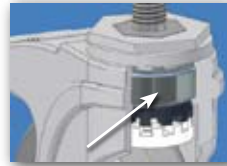

Precision sealed ball bearing raceway design for smooth, quiet maintenance free ride.

- FEATURES**
- Sealed stainless steel precision bearing raceway, smooth and quiet
 - Total lock and direction lock brake models available
 - Wheels feature sealed stainless precision ball bearings and full thread guards
 - Resistant to most chemicals
 - Recessed Stainless axle with plastic cap covers
 - Maintenance free, requires no lubrication for rig or wheel

Our NS Series is similar to NG Series but with the added benefit of 304 stainless components making it excellent for wet environments.

HOLLOW KINGPIN MODELS

Precision sealed ball bearing raceway design for smooth, quiet maintenance free ride.

Wheel Diameter (Inches)	Tread Width (Inches)	Wheel Description	Capacity (Lbs)	Load Height Inches (mm)	Swivel Radius Inches (mm)	Wheel Bearing	Model Number
3	1-1/4	QuikStart TPR	200	4-9/64" (105)	3-3/4" (95)	Precision Ball	NS-03QDP-125-SW-HKU1
3	1-1/4	QuikStart TPR	200	4-9/64" (105)	3-3/4" (95)	Plain	NS-03QDO-125-SW-HKU1
3	1-1/4	Anti-Microbial TPR	200	4-9/64" (105)	3-3/4" (95)	Precision Ball	NS-03AMP-125-SW-HKU1
4	1-1/4	QuikStart TPR	275	5-13/32" (137)	3-1/2" (89)	Precision Ball	NS-04QDP-125-SW-HKU1
4	1-1/4	Anti-Microbial TPR	275	5-13/32" (137)	3-1/2" (89)	Precision Ball	NS-04AMP-125-SW-HKU1
5	1-1/4	QuikStart TPR	325	6-1/2" (165)	3-1/2" (89)	Precision Ball	NS-05QDP-125-SW-HKU1
5	1-1/4	Anti-Microbial TPR	325	6-1/2" (165)	3-1/2" (89)	Precision Ball	NS-05AMP-125-SW-HKU1
6	1-1/4	QuikStart TPR	325	7-1/2" (191)	4-5/8" (117)	Precision Ball	NS-06QDP-125-SW-HKU1
6	1-1/4	QuikStart TPR	325	7-1/2" (191)	4-5/8" (117)	Plain	NS-06QDO-125-SW-HKU1
6	1-1/4	Anti-Microbial TPR	325	7-1/2" (191)	4-5/8" (117)	Precision Ball	NS-06AMP-125-SW-HKU1



316SS fittings available for non-magnetic applications. Consult factory.

HOLLOW KINGPIN

Caster is provided unassembled to make it easy to add your choice of fitting. If you would like these assembled change from HKU1 to HKO1. 1/2 I.D.



Custom Colors Available

NYLON PLUS STAINLESS (NS)

HOLLOW KINGPIN MODELS
FREE SWIVEL • TOTAL LOCK • DIRECTION LOCK

HOLLOW KINGPIN TOTAL LOCK MODELS

(LOCKS WHEEL AND SWIVEL)

Precision sealed ball bearing raceway design for smooth, quiet maintenance free ride.

Wheel Diameter (Inches)	Tread Width (Inches)	Wheel Description	Capacity (Lbs)	Load Height Inches (mm)	Swivel Radius Inches (mm)	Wheel Bearing	Model Number
3	1-1/4	QuikStart TPR	200	4-1/8" (105)	3-3/4" (96)	Precision Ball	NS-03QDP-125-TL-HKU1
3	1-1/4	QuikStart TPR	200	4-1/8" (105)	3-3/4" (96)	Plain	NS-03QDO-125-TL-HKU1
3	1-1/4	Anti-Microbial TPR	200	4-1/8" (105)	3-3/4" (96)	Precision Ball	NS-03AMP-125-TL-HKU1
4	1-1/4	QuikStart TPR	275	5-13/32" (137)	4-15/16" (125)	Precision Ball	NS-04QDP-125-TL-HKU1
4	1-1/4	Anti-Microbial TPR	275	5-13/32" (137)	4-15/16" (125)	Precision Ball	NS-04AMP-125-TL-HKU1
5	1-1/4	QuikStart TPR	325	6-1/2" (165)	4-15/16" (125)	Precision Ball	NS-05QDP-125-TL-HKU1
5	1-1/4	Anti-Microbial TPR	325	6-1/2" (165)	4-15/16" (125)	Precision Ball	NS-05AMP-125-TL-HKU1
6	1-1/4	QuikStart TPR	325	7-1/2" (191)	4-5/8" (117)	Precision Ball	NS-06QDP-125-TL-HKU1
6	1-1/4	QuikStart TPR	325	7-1/2" (191)	4-5/8" (117)	Plain	NS-06QDO-125-TL-HKU1
6	1-1/4	Anti-Microbial TPR	325	7-1/2" (191)	4-5/8" (117)	Precision Ball	NS-06AMP-125-TL-HKU1



HOLLOW KINGPIN DIRECTION LOCK MODELS

(LOCKS SWIVEL ONLY)

Precision sealed ball bearing raceway design for smooth, quiet maintenance free ride.

Wheel Diameter (Inches)	Tread Width (Inches)	Wheel Description	Capacity (Lbs)	Load Height Inches (mm)	Swivel Radius Inches (mm)	Wheel Bearing	Model Number
3	1-1/4	QuikStart TPR	200	4-1/8" (105)	3-3/4" (96)	Precision Ball	NS-03QDP-125-DL-HKU1
3	1-1/4	QuikStart TPR	200	4-1/8" (105)	3-3/4" (96)	Plain	NS-03QDO-125-DL-HKU1
3	1-1/4	Anti-Microbial TPR	200	4-1/8" (105)	3-3/4" (96)	Precision Ball	NS-03AMP-125-DL-HKU1
4	1-1/4	QuikStart TPR	275	5-13/32" (137)	4-15/16" (125)	Precision Ball	NS-04QDP-125-DL-HKU1
4	1-1/4	Anti-Microbial TPR	275	5-13/32" (137)	4-15/16" (125)	Precision Ball	NS-04AMP-125-DL-HKU1
5	1-1/4	QuikStart TPR	325	6-1/2" (165)	4-15/16" (125)	Precision Ball	NS-05QDP-125-DL-HKU1
5	1-1/4	Anti-Microbial TPR	325	6-1/2" (165)	4-15/16" (125)	Precision Ball	NS-05AMP-125-DL-HKU1
6	1-1/4	QuikStart TPR	325	7-1/2" (191)	4-5/8" (117)	Precision Ball	NS-06QDP-125-DL-HKU1
6	1-1/4	QuikStart TPR	325	7-1/2" (191)	4-5/8" (117)	Plain	NS-06QDO-125-DL-HKU1
6	1-1/4	Anti-Microbial TPR	325	7-1/2" (191)	4-5/8" (117)	Precision Ball	NS-06AMP-125-DL-HKU1



Our Directional Lock casters are designed to lock the swivel but not the wheel allowing you to steer your equipment. The directional lock feature is designed to break free under heavier load when the unit is traversing a corner only to lock back into position when the unit resumes a straight course.

HOLLOW KINGPIN

Caster is provided unassembled to make it easy to add your choice of fitting. If you would like these assembled change from HKU1 to HKO1. 1/2 I.D.

NYLON PLUS STAINLESS (NS)

EXPANDING ADAPTER STEM MODELS
FREE SWIVEL • TOTAL LOCK • DIRECTION LOCK



- APPLIC**
- Food Service Equipment
 - Case Carts
 - Utility Carts
 - Medical Equipment
 - Institutional Equipment
 - Hospital Carts
 - Animal Cage Carts
 - Pharmaceutical Equipment

- FEATURES**
- Sealed stainless steel precision bearing raceway, smooth and quiet
 - Total lock and direction lock brake models available
 - Wheels feature sealed stainless precision ball bearings and full thread guards
 - Resistant to most chemicals
 - Recessed Stainless axle with plastic cap covers
 - Maintenance free, requires no lubrication for rig or wheel

304 Stainless steel components!



Precision sealed ball bearing raceway design for smooth, quiet maintenance free ride.

Our NS Series is similar to NG Series but with the added benefit of 304 stainless components making it excellent for wet environments.

EXPANDING ADAPTER STEM MODELS

Precision sealed ball bearing raceway design for smooth, quiet maintenance free ride.

Wheel Diameter (Inches)	Tread Width (Inches)	Wheel Description	Capacity (Lbs)	Load Height Inches (mm)	Swivel Radius Inches (mm)	Wheel Bearing	Model Number
3	1-1/4	QuikStart TPR	200	4-9/64" (105)	3-3/4" (95)	Precision Ball	NS-03QDP-125-SW-___
3	1-1/4	QuikStart TPR	200	4-9/64" (105)	3-3/4" (95)	Plain	NS-03QDO-125-SW-___
3	1-1/4	Anti-Microbial TPR	200	4-9/64" (105)	3-3/4" (95)	Precision Ball	NS-03AMP-125-SW-___
4	1-1/4	QuikStart TPR	275	5-13/32" (137)	3-1/2" (89)	Precision Ball	NS-04QDP-125-SW-___
4	1-1/4	Anti-Microbial TPR	275	5-13/32" (137)	3-1/2" (89)	Precision Ball	NS-04AMP-125-SW-___
5	1-1/4	QuikStart TPR	325	6-1/2" (165)	3-1/2" (89)	Precision Ball	NS-05QDP-125-SW-___
5	1-1/4	Anti-Microbial TPR	325	6-1/2" (165)	3-1/2" (89)	Precision Ball	NS-05AMP-125-SW-___
6	1-1/4	QuikStart TPR	325	7-1/2" (191)	4-5/8" (117)	Precision Ball	NS-06QDP-125-SW-___
6	1-1/4	QuikStart TPR	325	7-1/2" (191)	4-5/8" (117)	Plain	NS-06QDO-125-SW-___
6	1-1/4	Anti-Microbial TPR	325	7-1/2" (191)	4-5/8" (117)	Precision Ball	NS-06AMP-125-SW-___



316SS fittings available for non-magnetic applications. Consult factory.

Specify Expanding Adapter Stem Round Nylon (XRN) code, Round Zamac (XRZ). see fittings at left for dimensions:

EXPANDING ADAPTER STEM FITTINGS

See fittings page for more options.

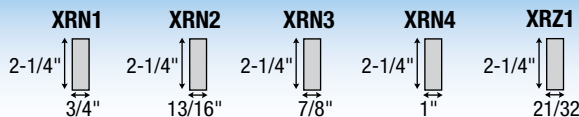

NYLON PLUS STAINLESS (NS)

EXPANDING ADAPTER STEM MODELS
FREE SWIVEL • TOTAL LOCK • DIRECTION LOCK

EXPANDING ADAPTER STEM TOTAL LOCK MODELS (LOCKS WHEEL AND SWIVEL)

Precision sealed ball bearing raceway design for smooth, quiet maintenance free ride.

Wheel Diameter (Inches)	Tread Width (Inches)	Wheel Description	Capacity (Lbs)	Load Height Inches (mm)	Swivel Radius Inches (mm)	Wheel Bearing	Model Number
3	1-1/4	QuikStart TPR	200	4-1/8" (105)	3-3/4" (96)	Precision Ball	NS-03QDP-125-TL-___
3	1-1/4	QuikStart TPR	200	4-1/8" (105)	3-3/4" (96)	Plain	NS-03QDO-125-TL-___
3	1-1/4	Anti-Microbial TPR	200	4-1/8" (105)	3-3/4" (96)	Precision Ball	NS-03AMP-125-TL-___
4	1-1/4	QuikStart TPR	275	5-13/32" (137)	4-15/16" (125)	Precision Ball	NS-04QDP-125-TL-___
4	1-1/4	Anti-Microbial TPR	275	5-13/32" (137)	4-15/16" (125)	Precision Ball	NS-04AMP-125-TL-___
5	1-1/4	QuikStart TPR	325	6-1/2" (165)	4-15/16" (125)	Precision Ball	NS-05QDP-125-TL-___
5	1-1/4	Anti-Microbial TPR	325	6-1/2" (165)	4-15/16" (125)	Precision Ball	NS-05AMP-125-TL-___
6	1-1/4	QuikStart TPR	325	7-1/2" (191)	4-5/8" (117)	Precision Ball	NS-06QDP-125-TL-___
6	1-1/4	QuikStart TPR	325	7-1/2" (191)	4-5/8" (117)	Plain	NS-06QDO-125-TL-___
6	1-1/4	Anti-Microbial TPR	325	7-1/2" (191)	4-5/8" (117)	Precision Ball	NS-06AMP-125-TL-___



EXPANDING ADAPTER STEM DIRECTION LOCK MODELS (LOCKS SWIVEL ONLY)

Precision sealed ball bearing raceway design for smooth, quiet maintenance free ride.

Wheel Diameter (Inches)	Tread Width (Inches)	Wheel Description	Capacity (Lbs)	Load Height Inches (mm)	Swivel Radius Inches (mm)	Wheel Bearing	Model Number
3	1-1/4	QuikStart TPR	200	4-1/8" (105)	3-3/4" (96)	Precision Ball	NS-03QDP-125-DL-___
3	1-1/4	QuikStart TPR	200	4-1/8" (105)	3-3/4" (96)	Plain	NS-03QDO-125-DL-___
3	1-1/4	Anti-Microbial TPR	200	4-1/8" (105)	3-3/4" (96)	Precision Ball	NS-03AMP-125-DL-___
4	1-1/4	QuikStart TPR	275	5-13/32" (137)	4-15/16" (125)	Precision Ball	NS-04QDP-125-DL-___
4	1-1/4	Anti-Microbial TPR	275	5-13/32" (137)	4-15/16" (125)	Precision Ball	NS-04AMP-125-DL-___
5	1-1/4	QuikStart TPR	325	6-1/2" (165)	4-15/16" (125)	Precision Ball	NS-05QDP-125-DL-___
5	1-1/4	Anti-Microbial TPR	325	6-1/2" (165)	4-15/16" (125)	Precision Ball	NS-05AMP-125-DL-___
6	1-1/4	QuikStart TPR	325	7-1/2" (191)	4-5/8" (117)	Precision Ball	NS-06QDP-125-DL-___
6	1-1/4	QuikStart TPR	325	7-1/2" (191)	4-5/8" (117)	Plain	NS-06QDO-125-DL-___
6	1-1/4	Anti-Microbial TPR	325	7-1/2" (191)	4-5/8" (117)	Precision Ball	NS-06AMP-125-DL-___



Our Directional Lock casters are designed to lock the swivel but not the wheel allowing you to steer your equipment. The directional lock feature is designed to break free under heavier load when the unit is traversing a corner only to lock back into position when the unit resumes a straight course.

Specify Expanding Adapter Stem Round Nylon (XRN) code, Round Zamac (XRZ). see fittings at left for dimensions:

EXPANDING ADAPTER STEM FITTINGS

See fittings page for more options.

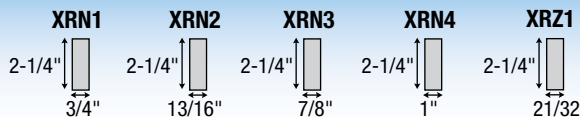

NYLON PLUS STAINLESS (NS)

THREADED STEM MODELS
FREE SWIVEL • TOTAL LOCK • DIRECTION LOCK



- APPLICATIONS**
- Food Service Equipment
 - Case Carts
 - Utility Carts
 - Medical Equipment
 - Institutional Equipment
 - Hospital Carts
 - Animal Cage Carts
 - Pharmaceutical Equipment

304 Stainless steel components!

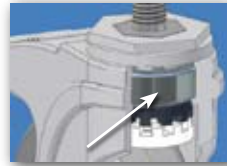

Precision sealed ball bearing raceway design for smooth, quiet maintenance free ride.

- FEATURES**
- Sealed stainless steel precision bearing raceway, smooth and quiet
 - Total lock and direction lock brake models available
 - Wheels feature sealed stainless precision ball bearings and full thread guards
 - Resistant to most chemicals
 - Recessed Stainless axle with plastic cap covers
 - Maintenance free, requires no lubrication for rig or wheel

Our NS Series is similar to NG Series but with the added benefit of 304 stainless components making it excellent for wet environments.

THREADED STEM MODELS

Precision sealed ball bearing raceway design for smooth, quiet maintenance free ride.

Wheel Diameter (Inches)	Tread Width (Inches)	Wheel Description	Capacity (Lbs)	Load Height Inches (mm)	Swivel Radius Inches (mm)	Wheel Bearing	Model Number
3	1-1/4	QuikStart TPR	200	4-9/64" (105)	3-3/4" (95)	Precision Ball	NS-03QDP-125-SW-___
3	1-1/4	QuikStart TPR	200	4-9/64" (105)	3-3/4" (95)	Plain	NS-03QDO-125-SW-___
3	1-1/4	Anti-Microbial TPR	200	4-9/64" (105)	3-3/4" (95)	Precision Ball	NS-03AMP-125-SW-___
4	1-1/4	QuikStart TPR	275	5-13/32" (137)	3-1/2" (89)	Precision Ball	NS-04QDP-125-SW-___
4	1-1/4	Anti-Microbial TPR	275	5-13/32" (137)	3-1/2" (89)	Precision Ball	NS-04AMP-125-SW-___
5	1-1/4	QuikStart TPR	325	6-1/2" (165)	3-1/2" (89)	Precision Ball	NS-05QDP-125-SW-___
5	1-1/4	Anti-Microbial TPR	325	6-1/2" (165)	3-1/2" (89)	Precision Ball	NS-05AMP-125-SW-___
6	1-1/4	QuikStart TPR	325	7-1/2" (191)	4-5/8" (117)	Precision Ball	NS-06QDP-125-SW-___
6	1-1/4	QuikStart TPR	325	7-1/2" (191)	4-5/8" (117)	Plain	NS-06QDO-125-SW-___
6	1-1/4	Anti-Microbial TPR	325	7-1/2" (191)	4-5/8" (117)	Precision Ball	NS-06AMP-125-SW-___



316SS fittings available for non-magnetic applications. Consult factory.

THREADED STEM FITTINGS

Stainless steel.
See fittings page for more options.

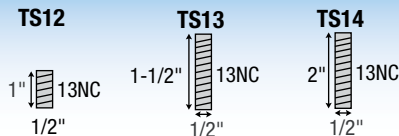

Specify Threaded Stem (TS) code, see fittings below for dimensions:

NYLON PLUS STAINLESS (NS)

THREADED STEM MODELS

FREE SWIVEL • TOTAL LOCK • DIRECTION LOCK

THREADED STEM TOTAL LOCK MODELS

(LOCKS WHEEL AND SWIVEL)

Precision sealed ball bearing raceway design for smooth, quiet maintenance free ride.

Wheel Diameter (Inches)	Tread Width (Inches)	Wheel Description	Capacity (Lbs)	Load Height Inches (mm)	Swivel Radius Inches (mm)	Wheel Bearing	Model Number
3	1-1/4	QuikStart TPR	200	4-1/8" (105)	3-3/4" (96)	Precision Ball	NS-03QDP-125-TL-___
3	1-1/4	QuikStart TPR	200	4-1/8" (105)	3-3/4" (96)	Plain	NS-03QDO-125-TL-___
3	1-1/4	Anti-Microbial TPR	200	4-1/8" (105)	3-3/4" (96)	Precision Ball	NS-03AMP-125-TL-___
4	1-1/4	QuikStart TPR	275	5-13/32" (137)	4-15/16" (125)	Precision Ball	NS-04QDP-125-TL-___
4	1-1/4	Anti-Microbial TPR	275	5-13/32" (137)	4-15/16" (125)	Precision Ball	NS-04AMP-125-TL-___
5	1-1/4	QuikStart TPR	325	6-1/2" (165)	4-15/16" (125)	Precision Ball	NS-05QDP-125-TL-___
5	1-1/4	Anti-Microbial TPR	325	6-1/2" (165)	4-15/16" (125)	Precision Ball	NS-05AMP-125-TL-___
6	1-1/4	QuikStart TPR	325	7-1/2" (191)	4-5/8" (117)	Precision Ball	NS-06QDP-125-TL-___
6	1-1/4	QuikStart TPR	325	7-1/2" (191)	4-5/8" (117)	Plain	NS-06QDO-125-TL-___
6	1-1/4	Anti-Microbial TPR	325	7-1/2" (191)	4-5/8" (117)	Precision Ball	NS-06AMP-125-TL-___



THREADED STEM DIRECTION LOCK MODELS

(LOCKS SWIVEL ONLY)

Precision sealed ball bearing raceway design for smooth, quiet maintenance free ride.

Wheel Diameter (Inches)	Tread Width (Inches)	Wheel Description	Capacity (Lbs)	Load Height Inches (mm)	Swivel Radius Inches (mm)	Wheel Bearing	Model Number
3	1-1/4	QuikStart TPR	200	4-1/8" (105)	3-3/4" (96)	Precision Ball	NS-03QDP-125-DL-___
3	1-1/4	QuikStart TPR	200	4-1/8" (105)	3-3/4" (96)	Plain	NS-03QDO-125-DL-___
3	1-1/4	Anti-Microbial TPR	200	4-1/8" (105)	3-3/4" (96)	Precision Ball	NS-03AMP-125-DL-___
4	1-1/4	QuikStart TPR	275	5-13/32" (137)	4-15/16" (125)	Precision Ball	NS-04QDP-125-DL-___
4	1-1/4	Anti-Microbial TPR	275	5-13/32" (137)	4-15/16" (125)	Precision Ball	NS-04AMP-125-DL-___
5	1-1/4	QuikStart TPR	325	6-1/2" (165)	4-15/16" (125)	Precision Ball	NS-05QDP-125-DL-___
5	1-1/4	Anti-Microbial TPR	325	6-1/2" (165)	4-15/16" (125)	Precision Ball	NS-05AMP-125-DL-___
6	1-1/4	QuikStart TPR	325	7-1/2" (191)	4-5/8" (117)	Precision Ball	NS-06QDP-125-DL-___
6	1-1/4	QuikStart TPR	325	7-1/2" (191)	4-5/8" (117)	Plain	NS-06QDO-125-DL-___
6	1-1/4	Anti-Microbial TPR	325	7-1/2" (191)	4-5/8" (117)	Precision Ball	NS-06AMP-125-DL-___



Our Directional Lock casters are designed to lock the swivel but not the wheel allowing you to steer your equipment. The directional lock feature is designed to break free under heavier load when the unit is traversing a corner only to lock back into position when the unit resumes a straight course.

Specify Threaded Stem (TS) code, see fittings below for dimensions:

THREADED STEM FITTINGS

Stainless steel.
See fittings page for more options.

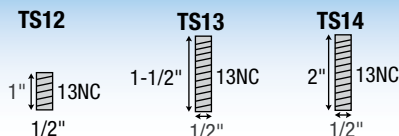

PLASTIC (PG)

TOP PLATE MODELS

FREE SWIVEL • TOTAL LOCK • DIRECTION LOCK



Standard color is silk grey

APPLICATIONS

- Food Service Equipment
- Case Carts
- Utility Carts
- Medical Equipment
- Institutional Equipment
- Hospital Carts
- Animal Cage Carts
- Cart Washable applications

4", 5", 6" & 8" wheel diameters

FEATURES

- Maintenance free
- Sealed precision bearing raceway
- Total Lock Brake models lock both swivel and wheel
- Directional lock models lock swivel only (helps with steering)
- Wheel feature precision bearings and full thread guards
- Rigs are made with glass filled nylon for added strength
- Resistance to most chemicals
- Recessed axle with plastic cap covers
- European style, yellow chromate top plate
- Operating temperatures good to 210° F intermittent

Our PG series provides you with that smooth European look and design.

SWIVEL TOP PLATE MODELS

Wheel Diameter (Inches)	Tread Width (Inches)	Wheel Description	Capacity (Lbs)	Load Height Inches (mm)	Swivel Radius Inches (mm)	Wheel Bearing	Model Number
4	1-1/4	Rubber on Plastic	220	5-23/32" (145)	3-15/32" (88)	Precision Ball	PG-04RPP-125-SW-TP01
4	1-1/4	Polyurethane TPU	220	5-23/32" (145)	3-15/32" (88)	Precision Ball	PG-04PYP-125-SW-TP01
5	1-1/4	Rubber on Plastic	220	6-9/16" (165)	4-5/6" (110)	Precision Ball	PG-05RPP-125-SW-TP01
5	1-1/4	Polyurethane TPU	220	6-9/16" (165)	4-5/6" (110)	Precision Ball	PG-05PYP-125-SW-TP01
6	1-1/4	Rubber on Plastic	264	8-1/32" (195)	4-57/64" (124)	Precision Ball	PG-06RPP-125-SW-TP01
6	1-1/4	Polyurethane TPU	264	8-1/32" (195)	4-57/64" (124)	Precision Ball	PG-06PYP-125-SW-TP01
8	1-1/4	Rubber on Plastic	264	10-13/64" (251)	6-9/16" (165)	Precision Ball	PG-08RPP-125-SW-TP01
8	1-1/4	Polyurethane TPU	264	10-13/64" (251)	6-9/16" (165)	Precision Ball	PG-08PYP-125-SW-TP01



TOP PLATE FITTING

Swivel Top Plate Pattern

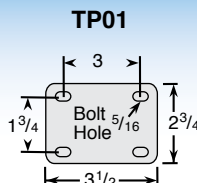

Dark grey also available, please consult factory.



PLASTIC (PG)

TOP PLATE MODELS

FREE SWIVEL • TOTAL LOCK • DIRECTION LOCK

SWIVEL TOP PLATE TOTAL LOCK MODELS

(LOCKS WHEEL AND SWIVEL)

Wheel Diameter (Inches)	Tread Width (Inches)	Wheel Description	Capacity (Lbs)	Load Height Inches (mm)	Swivel Radius Inches (mm)	Wheel Bearing	Model Number
4	1-1/4	Rubber on Plastic	220	5-23/32" (145)	4-21/64" (110)	Precision Ball	PG-04RPP-125-TL-TP01
4	1-1/4	Polyurethane TPU	220	5-23/32" (145)	4-21/64" (110)	Precision Ball	PG-04PYP-125-TL-TP01
5	1-1/4	Rubber on Plastic	220	6-9/16" (165)	4-23/32" (120)	Precision Ball	PG-05RPP-125-TL-TP01
5	1-1/4	Polyurethane TPU	220	6-9/16" (165)	4-23/32" (120)	Precision Ball	PG-05PYP-125-TL-TP01
6	1-1/4	Rubber on Plastic	264	8-1/32" (195)	5-9/32" (134)	Precision Ball	PG-06RPP-125-TL-TP01
6	1-1/4	Polyurethane TPU	264	8-1/32" (195)	5-9/32" (134)	Precision Ball	PG-06PYP-125-TL-TP01
8	1-1/4	Rubber on Plastic	264	10-13/64" (251)	5-29/32" (150)	Precision Ball	PG-08RPP-125-TL-TP01
8	1-1/4	Polyurethane TPU	264	10-13/64" (251)	5-29/32" (150)	Precision Ball	PG-08PYP-125-TL-TP01



SWIVEL TOP PLATE DIRECTION LOCK MODELS

(LOCKS SWIVEL ONLY)

Wheel Diameter (Inches)	Tread Width (Inches)	Wheel Description	Capacity (Lbs)	Load Height Inches (mm)	Swivel Radius Inches (mm)	Wheel Bearing	Model Number
4	1-1/4	Rubber on Plastic	220	5-23/32" (145)	4-21/64" (110)	Precision Ball	PG-04RPP-125-DL-TP01
4	1-1/4	Polyurethane TPU	220	5-23/32" (145)	4-21/64" (110)	Precision Ball	PG-04PYP-125-DL-TP01
5	1-1/4	Rubber on Plastic	220	6-9/16" (165)	4-23/32" (120)	Precision Ball	PG-05RPP-125-DL-TP01
5	1-1/4	Polyurethane TPU	220	6-9/16" (165)	4-23/32" (120)	Precision Ball	PG-05PYP-125-DL-TP01
6	1-1/4	Rubber on Plastic	264	8-1/32" (195)	5-9/32" (134)	Precision Ball	PG-06RPP-125-DL-TP01
6	1-1/4	Polyurethane TPU	264	8-1/32" (195)	5-9/32" (134)	Precision Ball	PG-06PYP-125-DL-TP01
8	1-1/4	Rubber on Plastic	264	10-13/64" (251)	5-29/32" (150)	Precision Ball	PG-08RPP-125-DL-TP01
8	1-1/4	Polyurethane TPU	264	10-13/64" (251)	5-29/32" (150)	Precision Ball	PG-08PYP-125-DL-TP01



Our Directional Lock casters are designed to lock the swivel but not the wheel allowing you to steer your equipment. The directional lock feature is designed to break free under heavier load when the unit is traversing a corner only to lock back into position when the unit resumes a straight course.

TOP PLATE FITTING

TP01

Swivel Top Plate Pattern

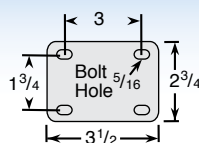

PLASTIC (PG)

HOLLOW KINGPIN MODELS

FREE SWIVEL • TOTAL LOCK • DIRECTION LOCK

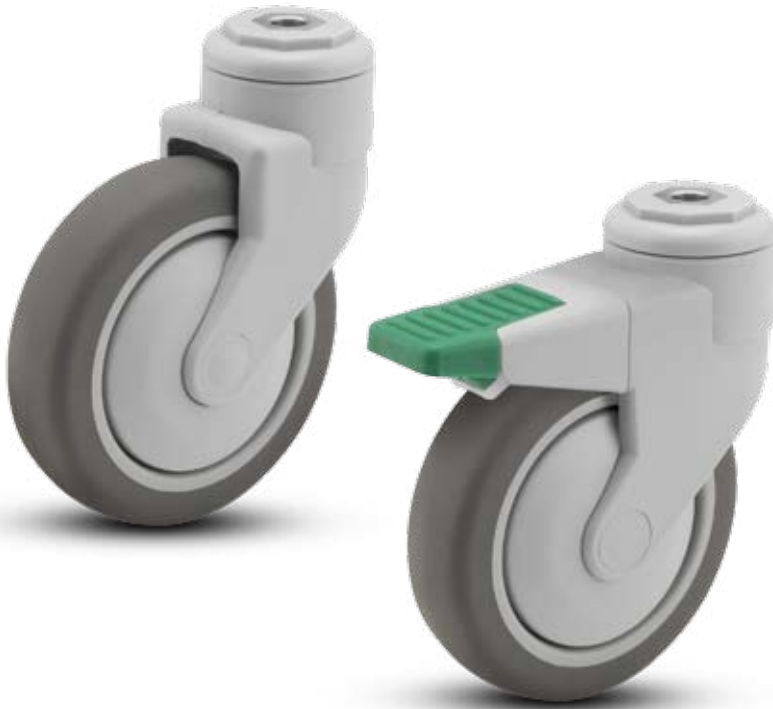

- APPLICATIONS**
- Food Service Equipment
 - Case Carts
 - Utility Carts
 - Medical Equipment
 - Institutional Equipment
 - Hospital Carts
 - Animal Cage Carts
 - Cart Washable applications

4", 5", 6"
& 8" wheel
diameters

- FEATURES**
- Maintenance free
 - Sealed precision bearing raceway
 - Total Lock Brake models lock both swivel and wheel
 - Directional lock models lock swivel only (helps with steering)
 - Wheel feature precision bearings and full thread guards
 - Rigs are made with glass filled nylon for added strength
 - Resistance to most chemicals
 - Recessed axle with plastic cap covers
 - Operating temperatures good to 210° F intermittent

Our PG series provides you with that smooth European look and design.

HOLLOW KINGPIN MODELS

Wheel Diameter (Inches)	Tread Width (Inches)	Wheel Description	Capacity (Lbs)	Load Height Inches (mm)	Swivel Radius Inches (mm)	Wheel Bearing	Model Number
4	1-1/4	Rubber on Plastic	220	5-45/64" (145)	3-15/32" (88)	Precision Ball	PG-04RPP-125-SW-HKU1
4	1-1/4	Polyurethane TPU	220	5-45/64" (145)	3-15/32" (88)	Precision Ball	PG-04PYP-125-SW-HKU1
5	1-1/4	Rubber on Plastic	220	6-1/2" (165)	4-5/6" (110)	Precision Ball	PG-05RPP-125-SW-HKU1
5	1-1/4	Polyurethane TPU	220	6-1/2" (165)	4-5/6" (110)	Precision Ball	PG-05PYP-125-SW-HKU1
6	1-1/4	Rubber on Plastic	264	7-25/32" (197)	4-57/64" (124)	Precision Ball	PG-06RPP-125-SW-HKU1
6	1-1/4	Polyurethane TPU	264	7-25/32" (197)	4-57/64" (124)	Precision Ball	PG-06PYP-125-SW-HKU1
8	1-1/4	Rubber on Plastic	264	9-7/8" (251)	6-9/16" (165)	Precision Ball	PG-08RPP-125-SW-HKU1
8	1-1/4	Polyurethane TPU	264	9-7/8" (251)	6-9/16" (165)	Precision Ball	PG-08PYP-125-SW-HKU1



HOLLOW KINGPIN

Caster is provided unassembled to make it easy to add your choice of fitting. If you would like these assembled change from HKU1 to HK01. 1/2 I.D.

Please see fitting pages for stems that can be added to this series.



PLASTIC (PG)

HOLLOW KINGPIN MODELS

FREE SWIVEL • TOTAL LOCK • DIRECTION LOCK

HOLLOW KINGPIN TOTAL LOCK MODELS

(LOCKS WHEEL AND SWIVEL)

Wheel Diameter (Inches)	Tread Width (Inches)	Wheel Description	Capacity (Lbs)	Load Height Inches (mm)	Swivel Radius Inches (mm)	Wheel Bearing	Model Number
4	1-1/4	Rubber on Plastic	220	5-45/64" (145)	4-21/64" (110)	Precision Ball	PG-04RPP-125-TL-HKU1
4	1-1/4	Polyurethane TPU	220	5-45/64" (145)	4-21/64" (110)	Precision Ball	PG-04PYP-125-TL-HKU1
5	1-1/4	Rubber on Plastic	220	6-1/2" (165)	4-23/32" (120)	Precision Ball	PG-05RPP-125-TL-HKU1
5	1-1/4	Polyurethane TPU	220	6-1/2" (165)	4-23/32" (120)	Precision Ball	PG-05PYP-125-TL-HKU1
6	1-1/4	Rubber on Plastic	264	7-25/32" (197)	5-9/32" (134)	Precision Ball	PG-06RPP-125-TL-HKU1
6	1-1/4	Polyurethane TPU	264	7-25/32" (197)	5-9/32" (134)	Precision Ball	PG-06PYP-125-TL-HKU1
8	1-1/4	Rubber on Plastic	264	9-7/8" (251)	5-29/32" (150)	Precision Ball	PG-08RPP-125-TL-HKU1
8	1-1/4	Polyurethane TPU	264	9-7/8" (251)	5-29/32" (150)	Precision Ball	PG-08PYP-125-TL-HKU1



HOLLOW KINGPIN DIRECTION LOCK MODELS

(LOCKS SWIVEL ONLY)

Wheel Diameter (Inches)	Tread Width (Inches)	Wheel Description	Capacity (Lbs)	Load Height Inches (mm)	Swivel Radius Inches (mm)	Wheel Bearing	Model Number
4	1-1/4	Rubber on Plastic	220	5-45/64" (145)	4-21/64" (110)	Precision Ball	PG-04RPP-125-DL-HKU1
4	1-1/4	Polyurethane TPU	220	5-45/64" (145)	4-21/64" (110)	Precision Ball	PG-04PYP-125-DL-HKU1
5	1-1/4	Rubber on Plastic	220	6-1/2" (165)	4-23/32" (120)	Precision Ball	PG-05RPP-125-DL-HKU1
5	1-1/4	Polyurethane TPU	220	6-1/2" (165)	4-23/32" (120)	Precision Ball	PG-05PYP-125-DL-HKU1
6	1-1/4	Rubber on Plastic	264	7-25/32" (197)	5-9/32" (134)	Precision Ball	PG-06RPP-125-DL-HKU1
6	1-1/4	Polyurethane TPU	264	7-25/32" (197)	5-9/32" (134)	Precision Ball	PG-06PYP-125-DL-HKU1
8	1-1/4	Rubber on Plastic	264	9-7/8" (251)	5-29/32" (150)	Precision Ball	PG-08RPP-125-DL-HKU1
8	1-1/4	Polyurethane TPU	264	9-7/8" (251)	5-29/32" (150)	Precision Ball	PG-08PYP-125-DL-HKU1



Our Directional Lock casters are designed to lock the swivel but not the wheel allowing you to steer your equipment. The directional lock feature is designed to break free under heavier load when the unit is traversing a corner only to lock back into position when the unit resumes a straight course.

HOLLOW KINGPIN

Caster is provided unassembled to make it easy to add your choice of fitting. If you would like these assembled change from HKU1 to HK01. 1/2 I.D.

Please see fitting pages for stems that can be added to this series.

PLASTIC (PG)

GRIP RING STEM MODELS

FREE SWIVEL • TOTAL LOCK • DIRECTION LOCK

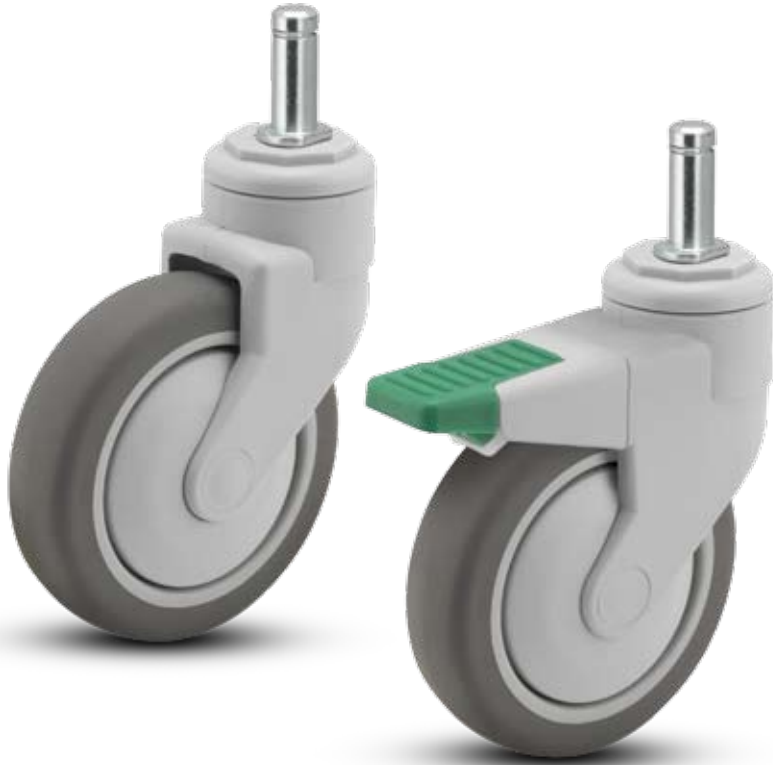

- ### APPLICATIONS
- Food Service Equipment
 - Case Carts
 - Utility Carts
 - Medical Equipment
 - Institutional Equipment
 - Hospital Carts
 - Animal Cage Carts
 - Cart Washable applications

4", 5", 6" & 8" wheel diameters

- ### FEATURES
- Maintenance free
 - Sealed precision bearing raceway
 - Total Lock Brake models lock both swivel and wheel
 - Directional lock models lock swivel only (helps with steering)
 - Wheel feature precision bearings and full thread guards
 - Rigs are made with glass filled nylon for added strength
 - Resistance to most chemicals
 - Recessed axle with plastic cap covers
 - Operating temperatures good to 210° F intermittent

Our PG series provides you with that smooth European look and design.

GRIP RING STEM MODELS

Wheel Diameter (Inches)	Tread Width (Inches)	Wheel Description	Capacity (Lbs)	Load Height Inches (mm)	Swivel Radius Inches (mm)	Wheel Bearing	Model Number
4	1-1/4	Rubber on Plastic	220	5-45/64" (145)	3-15/32" (88)	Precision Ball	PG-04RPP-125-SW-___
4	1-1/4	Polyurethane TPU	220	5-45/64" (145)	3-15/32" (88)	Precision Ball	PG-04PYP-125-SW-___
5	1-1/4	Rubber on Plastic	220	6-1/2" (165)	4-5/6" (110)	Precision Ball	PG-05RPP-125-SW-___
5	1-1/4	Polyurethane TPU	220	6-1/2" (165)	4-5/6" (110)	Precision Ball	PG-05PYP-125-SW-___
6	1-1/4	Rubber on Plastic	264	7-25/32" (197)	4-57/64" (124)	Precision Ball	PG-06RPP-125-SW-___
6	1-1/4	Polyurethane TPU	264	7-25/32" (197)	4-57/64" (124)	Precision Ball	PG-06PYP-125-SW-___
8	1-1/4	Rubber on Plastic	264	9-7/8" (251)	6-9/16" (165)	Precision Ball	PG-08RPP-125-SW-___
8	1-1/4	Polyurethane TPU	264	9-7/8" (251)	6-9/16" (165)	Precision Ball	PG-08PYP-125-SW-___



GRIP RING STEM FITTINGS

Easy to install grip rings snap into place. See fittings page for more options.

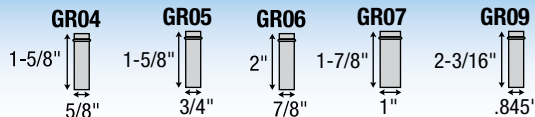

Specify Grip Ring Stem (GR) code, see fittings below for dimensions:

PLASTIC (PG)

GRIP RING STEM MODELS

FREE SWIVEL • TOTAL LOCK • DIRECTION LOCK

GRIP RING STEM TOTAL LOCK MODELS

(LOCKS WHEEL AND SWIVEL)

Wheel Diameter (Inches)	Tread Width (Inches)	Wheel Description	Capacity (lbs)	Load Height Inches (mm)	Swivel Radius Inches (mm)	Wheel Bearing	Model Number
4	1-1/4	Rubber on Plastic	220	5-45/64" (145)	4-21/64" (110)	Precision Ball	PG-04RPP-125-TL-___
4	1-1/4	Polyurethane TPU	220	5-45/64" (145)	4-21/64" (110)	Precision Ball	PG-04PYP-125-TL-___
5	1-1/4	Rubber on Plastic	220	6-1/2" (165)	4-23/32" (120)	Precision Ball	PG-05RPP-125-TL-___
5	1-1/4	Polyurethane TPU	220	6-1/2" (165)	4-23/32" (120)	Precision Ball	PG-05PYP-125-TL-___
6	1-1/4	Rubber on Plastic	264	7-25/32" (197)	5-9/32" (134)	Precision Ball	PG-06RPP-125-TL-___
6	1-1/4	Polyurethane TPU	264	7-25/32" (197)	5-9/32" (134)	Precision Ball	PG-06PYP-125-TL-___
8	1-1/4	Rubber on Plastic	264	9-7/8" (251)	5-29/32" (150)	Precision Ball	PG-08RPP-125-TL-___
8	1-1/4	Polyurethane TPU	264	9-7/8" (251)	5-29/32" (150)	Precision Ball	PG-08PYP-125-TL-___



GRIP RING STEM DIRECTION LOCK MODELS

(LOCKS SWIVEL ONLY)

Wheel Diameter (Inches)	Tread Width (Inches)	Wheel Description	Capacity (lbs)	Load Height Inches (mm)	Swivel Radius Inches (mm)	Wheel Bearing	Model Number
4	1-1/4	Rubber on Plastic	220	5-45/64" (145)	4-21/64" (110)	Precision Ball	PG-04RPP-125-DL-___
4	1-1/4	Polyurethane TPU	220	5-45/64" (145)	4-21/64" (110)	Precision Ball	PG-04PYP-125-DL-___
5	1-1/4	Rubber on Plastic	220	6-1/2" (165)	4-23/32" (120)	Precision Ball	PG-05RPP-125-DL-___
5	1-1/4	Polyurethane TPU	220	6-1/2" (165)	4-23/32" (120)	Precision Ball	PG-05PYP-125-DL-___
6	1-1/4	Rubber on Plastic	264	7-25/32" (197)	5-9/32" (134)	Precision Ball	PG-06RPP-125-DL-___
6	1-1/4	Polyurethane TPU	264	7-25/32" (197)	5-9/32" (134)	Precision Ball	PG-06PYP-125-DL-___
8	1-1/4	Rubber on Plastic	264	9-7/8" (251)	5-29/32" (150)	Precision Ball	PG-08RPP-125-DL-___
8	1-1/4	Polyurethane TPU	264	9-7/8" (251)	5-29/32" (150)	Precision Ball	PG-08PYP-125-DL-___



Our Directional Lock casters are designed to lock the swivel but not the wheel allowing you to steer your equipment. The directional lock feature is designed to break free under heavier load when the unit is traversing a corner only to lock back into position when the unit resumes a straight course.

GRIP RING STEM FITTINGS

Easy to install grip rings snap into place. See fittings page for more options.

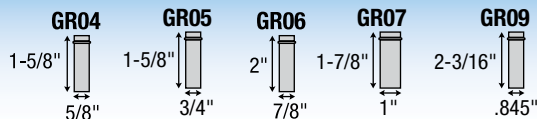

Specify Grip Ring Stem (GR) code, see fittings below for dimensions:

PLASTIC (PG)

THREADED STEM MODELS

FREE SWIVEL • TOTAL LOCK • DIRECTION LOCK



- ### APPLICATIONS
- Food Service Equipment
 - Case Carts
 - Utility Carts
 - Medical Equipment
 - Institutional Equipment
 - Hospital Carts
 - Animal Cage Carts
 - Cart Washable applications

4", 5", 6"
& 8" wheel
diameters

- ### FEATURES
- Maintenance free
 - Sealed precision bearing raceway
 - Total Lock Brake models lock both swivel and wheel
 - Directional lock models lock swivel only (helps with steering)
 - Wheel feature precision bearings and full thread guards
 - Rigs are made with glass filled nylon for added strength
 - Resistance to most chemicals
 - Recessed axle with plastic cap covers
 - Operating temperatures good to 210° F intermittent

Our PG series provides you with that smooth European look and design.

THREADED STEM MODELS

Wheel Diameter (Inches)	Tread Width (Inches)	Wheel Description	Capacity (Lbs)	Load Height Inches (mm)	Swivel Radius Inches (mm)	Wheel Bearing	Model Number
4	1-1/4	Rubber on Plastic	220	5-45/64" (145)	3-15/32" (88)	Precision Ball	PG-04RPP-125-SW-___
4	1-1/4	Polyurethane TPU	220	5-45/64" (145)	3-15/32" (88)	Precision Ball	PG-04PYP-125-SW-___
5	1-1/4	Rubber on Plastic	220	6-1/2" (165)	4-5/6" (110)	Precision Ball	PG-05RPP-125-SW-___
5	1-1/4	Polyurethane TPU	220	6-1/2" (165)	4-5/6" (110)	Precision Ball	PG-05PYP-125-SW-___
6	1-1/4	Rubber on Plastic	264	7-25/32" (197)	4-57/64" (124)	Precision Ball	PG-06RPP-125-SW-___
6	1-1/4	Polyurethane TPU	264	7-25/32" (197)	4-57/64" (124)	Precision Ball	PG-06PYP-125-SW-___
8	1-1/4	Rubber on Plastic	264	9-7/8" (251)	6-9/16" (165)	Precision Ball	PG-08RPP-125-SW-___
8	1-1/4	Polyurethane TPU	264	9-7/8" (251)	6-9/16" (165)	Precision Ball	PG-08PYP-125-SW-___



THREADED STEM FITTINGS

Easy to install stem.
See fittings page for more options.

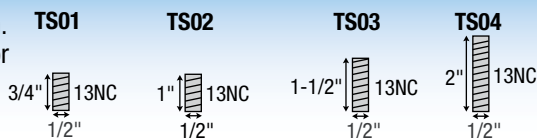

Specify Threaded Stem (TS) code, see fittings below for dimensions:

PLASTIC (PG)

THREADED STEM MODELS

FREE SWIVEL • TOTAL LOCK • DIRECTION LOCK

THREADED STEM TOTAL LOCK MODELS

(LOCKS WHEEL AND SWIVEL)

Wheel Diameter (Inches)	Tread Width (Inches)	Wheel Description	Capacity (Lbs)	Load Height Inches (mm)	Swivel Radius Inches (mm)	Wheel Bearing	Model Number
4	1-1/4	Rubber on Plastic	220	5-45/64" (145)	4-21/64" (110)	Precision Ball	PG-04RPP-125-TL-___
4	1-1/4	Polyurethane TPU	220	5-45/64" (145)	4-21/64" (110)	Precision Ball	PG-04PYP-125-TL-___
5	1-1/4	Rubber on Plastic	220	6-1/2" (165)	4-23/32" (120)	Precision Ball	PG-05RPP-125-TL-___
5	1-1/4	Polyurethane TPU	220	6-1/2" (165)	4-23/32" (120)	Precision Ball	PG-05PYP-125-TL-___
6	1-1/4	Rubber on Plastic	264	7-25/32" (197)	4-57/64" (124)	Precision Ball	PG-06RPP-125-TL-___
6	1-1/4	Polyurethane TPU	264	7-25/32" (197)	4-57/64" (124)	Precision Ball	PG-06PYP-125-TL-___
8	1-1/4	Rubber on Plastic	264	9-7/8" (251)	5-29/32" (150)	Precision Ball	PG-08RPP-125-TL-___
8	1-1/4	Polyurethane TPU	264	9-7/8" (251)	5-29/32" (150)	Precision Ball	PG-08PYP-125-TL-___



THREADED STEM DIRECTION LOCK MODELS

(LOCKS SWIVEL ONLY)

Wheel Diameter (Inches)	Tread Width (Inches)	Wheel Description	Capacity (Lbs)	Load Height Inches (mm)	Swivel Radius Inches (mm)	Wheel Bearing	Model Number
4	1-1/4	Rubber on Plastic	220	5-45/64" (145)	4-21/64" (110)	Precision Ball	PG-04RPP-125-DL-___
4	1-1/4	Polyurethane TPU	220	5-45/64" (145)	4-21/64" (110)	Precision Ball	PG-04PYP-125-DL-___
5	1-1/4	Rubber on Plastic	220	6-1/2" (165)	4-15/16" (125)	Precision Ball	PG-05RPP-125-DL-___
5	1-1/4	Polyurethane TPU	220	6-1/2" (165)	4-15/16" (125)	Precision Ball	PG-05PYP-125-DL-___
6	1-1/4	Rubber on Plastic	264	7-25/32" (197)	4-23/32" (120)	Precision Ball	PG-06RPP-125-DL-___
6	1-1/4	Polyurethane TPU	264	7-25/32" (197)	4-23/32" (120)	Precision Ball	PG-06PYP-125-DL-___
8	1-1/4	Rubber on Plastic	264	9-7/8" (251)	5-29/32" (150)	Precision Ball	PG-08RPP-125-DL-___
8	1-1/4	Polyurethane TPU	264	9-7/8" (251)	5-29/32" (150)	Precision Ball	PG-08PYP-125-DL-___



Our Directional Lock casters are designed to lock the swivel but not the wheel allowing you to steer your equipment. The directional lock feature is designed to break free under heavier load when the unit is traversing a corner only to lock back into position when the unit resumes a straight course.

Specify Threaded Stem (TS) code, see fittings below for dimensions:

THREADED STEM FITTINGS

Easy to install stem. See fittings page for more options.

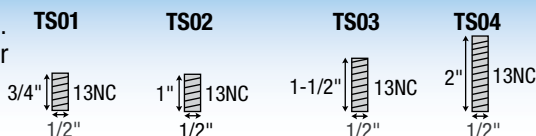

PLASTIC ANTISTATIC (PA)

TOP PLATE MODELS

FREE SWIVEL • TOTAL LOCK • DIRECTION LOCK



- APPLICATIONS**
- Computer equipment
 - Electronic Equipment
 - Case Carts
 - Utility Carts
 - Medical Equipment
 - Institutional Equipment
 - Hospital Carts
 - Cart Washable applications

- FEATURES**
- Sealed Precision Bearing raceway, smooth and quiet
 - Total Lock Brake models lock both swivel and wheel
 - Directional lock models lock swivel only (helps with Steering)
 - Wheel feature precision bearings and full thread guards
 - Resistance to most chemicals
 - Recessed axle with Yellow plastic cap covers
 - Maintenance Free
 - European style, Yellow chromate top plate

Molded electronically conductive polyamide housing is water proof and features precision ball bearings. Wheel and fork standard color is dark gray.

SWIVEL TOP PLATE MODELS

Wheel Diameter (Inches)	Tread Width (Inches)	Wheel Description	Capacity (Lbs)	Load Height Inches (mm)	Swivel Radius Inches (mm)	Wheel Bearing	Model Number
4	1-1/4	Antistatic Poly	220	5-23/32" (145)	3-15/32" (88)	Precision Ball	PA-04APP-125-SW-TP01
5	1-1/4	Antistatic Poly	220	6-9/16" (165)	4-5/6" (110)	Precision Ball	PA-05APP-125-SW-TP01
6	1-1/4	Antistatic Poly	264	8-1/32" (195)	4-57/64" (124)	Precision Ball	PA-06APP-125-SW-TP01
8	1-1/4	Antistatic Poly	264	10-13/64" (251)	6-9/16" (165)	Precision Ball	PA-08APP-125-SW-TP01



SWIVEL TOP PLATE TOTAL LOCK MODELS

4	1-1/4	Antistatic Poly	220	5-23/32" (145)	4-21/64" (110)	Precision Ball	PA-04APP-125-TL-TP01
5	1-1/4	Antistatic Poly	220	6-9/16" (165)	4-23/32" (120)	Precision Ball	PA-05APP-125-TL-TP01
6	1-1/4	Antistatic Poly	264	8-1/32" (195)	5-9/32" (134)	Precision Ball	PA-06APP-125-TL-TP01
8	1-1/4	Antistatic Poly	264	10-13/64" (251)	5-29/32" (150)	Precision Ball	PA-08APP-125-TL-TP01



SWIVEL TOP PLATE DIRECTION LOCK MODELS

(LOCKS SWIVEL ONLY)

4	1-1/4	Antistatic Poly	220	5-23/32" (145)	4-21/64" (110)	Precision Ball	PA-04APP-125-SW-TP01
5	1-1/4	Antistatic Poly	220	6-9/16" (165)	4-23/32" (120)	Precision Ball	PA-05APP-125-SW-TP01
6	1-1/4	Antistatic Poly	264	8-1/32" (195)	5-9/32" (134)	Precision Ball	PA-06APP-125-SW-TP01
8	1-1/4	Antistatic Poly	264	10-13/64" (251)	5-29/32" (150)	Precision Ball	PA-08APP-125-SW-TP01



TOP PLATE FITTING

Swivel Top Plate Pattern

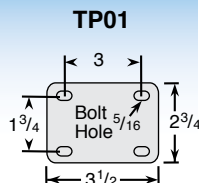

Our Directional Lock casters are designed to lock the swivel but not the wheel allowing you to steer your equipment. The directional lock feature is designed to break free under heavier load when the unit is traversing a corner only to lock back into position when the unit resumes a straight course.

Both the caster fork and wheel are electrically conductive. Caster conforms to CEN standards with resistance values < 10,000 ohms (measured at 500V DC, with minimum output of 50 V DC at 1,000 ohms resistance).

PLASTIC ANTISTATIC (PA)

THREADED STEM MODELS

FREE SWIVEL • TOTAL LOCK • DIRECTION LOCK

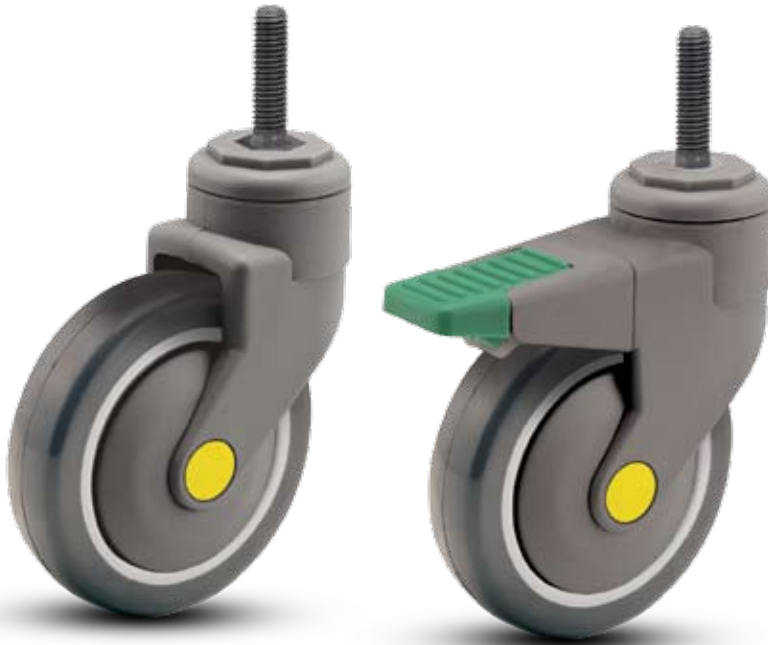

Hollow rivet models available. Consult factory.

- APPLICATIONS**
- Computer equipment
 - Electronic Equipment
 - Case Carts
 - Utility Carts
 - Medical Equipment
 - Institutional Equipment
 - Hospital Carts
 - Cart Washable applications

- FEATURES**
- Sealed Precision Bearing raceway, smooth and quiet
 - Total Lock Brake models lock both swivel and wheel
 - Directional lock models lock swivel only (helps with Steering)
 - Wheel feature precision bearings and full thread guards
 - Resistance to most chemicals
 - Recessed axle with Yellow plastic cap covers
 - Maintenance Free

Molded electronically conductive polyamide housing is water proof and features precision ball bearings. Wheel and fork standard color is dark gray.

THREADED STEM MODELS

Wheel Diameter (Inches)	Tread Width (Inches)	Wheel Description	Capacity (Lbs)	Load Height Inches (mm)	Swivel Radius Inches (mm)	Wheel Bearing	Model Number
4	1-1/4	Antistatic Poly	220	5-45/64" (145)	3-15/32" (88)	Precision Ball	PA-04APP-125-SW-__
5	1-1/4	Antistatic Poly	220	6-1/2" (165)	4-5/6" (110)	Precision Ball	PA-05APP-125-SW-__
6	1-1/4	Antistatic Poly	264	7-25/32" (197)	4-57/64" (124)	Precision Ball	PA-06APP-125-SW-__
8	1-1/4	Antistatic Poly	264	9-7/8" (251)	6-9/16" (165)	Precision Ball	PA-08APP-125-SW-__



THREADED STEM TOTAL LOCK MODELS

(LOCKS WHEEL AND SWIVEL)

4	1-1/4	Antistatic Poly	220	5-45/64" (145)	4-21/64" (110)	Precision Ball	PA-04APP-125-TL-__
5	1-1/4	Antistatic Poly	220	6-1/2" (165)	4-23/32" (120)	Precision Ball	PA-05APP-125-TL-__
6	1-1/4	Antistatic Poly	264	7-25/32" (197)	5-9/32" (134)	Precision Ball	PA-06APP-125-TL-__
8	1-1/4	Antistatic Poly	264	9-7/8" (251)	5-9/32" (134)	Precision Ball	PA-08APP-125-TL-__



THREADED STEM DIRECTION LOCK MODELS

(LOCKS SWIVEL ONLY)

4	1-1/4	Antistatic Poly	220	5-45/64" (145)	4-21/64" (110)	Precision Ball	PA-04APP-125-SW-__
5	1-1/4	Antistatic Poly	220	6-1/2" (165)	4-23/32" (120)	Precision Ball	PA-05APP-125-SW-__
6	1-1/4	Antistatic Poly	264	7-25/32" (197)	5-9/32" (134)	Precision Ball	PA-06APP-125-SW-__
8	1-1/4	Antistatic Poly	264	9-7/8" (251)	5-9/32" (134)	Precision Ball	PA-08APP-125-SW-__



Our Directional Lock casters are designed to lock the swivel but not the wheel allowing you to steer your equipment. The directional lock feature is designed to break free under heavier load when the unit is traversing a corner only to lock back into position when the unit resumes a straight course.

Specify Threaded Stem (TS) code, see fittings below for dimensions:

THREADED STEM FITTINGS

Easy to install stem. See fittings page for more options.

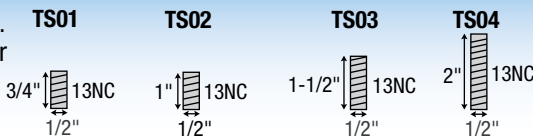

Both the caster fork and wheel are electrically conductive. Caster conforms to CEN standards with resistance values < 10,000 ohms (measured at 500V DC, with minimum output of 50 V DC at 1,000 ohms resistance).

MEDCASTER BED CASTERS

MED-BED (MB)



New central lock
brake design

**HOSPITAL BED
PLASTIC (HP)**



Sturdy Nylon
Glass Filled

**HOSPITAL BED
STAINLESS (HS)**



304 Stainless Steel
Finish

**HOSPITAL BED
CHROME (HC)**



Attractive Chrome
Finish

**MED-BED
ULTRA (MU)**



Twin Wheel
Easy Turning in Tight
Spots

Typical Configurations for our Hospital bed Casters

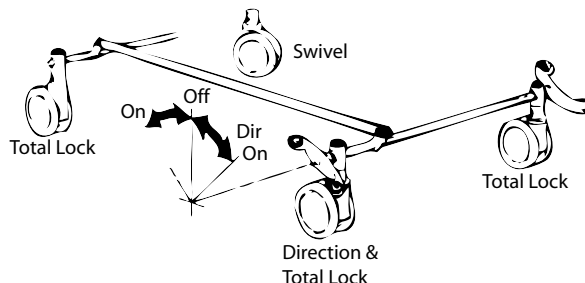
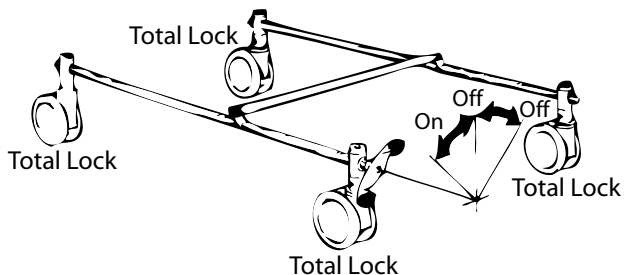

Bed System Caster Accessories



T3: double lever,
round profile



A1: double lever in
chrome, flat profile



C1: steel
adapter



B5:
adapter



B3: change
lever



B1: chrome
change lever

MED-BED (MB)

FREE SWIVEL • TOTAL LOCK •
TOTAL/DIRECTION LOCK COMBO



New 8" Wheel Diameter Model

APPLICATIONS

Anti-Microbial wheels available. Consult factory.

- ## FEATURES
- New 8" diameter models feature sealed precision ball raceway
 - Wheels have full plastic thread guards
 - Full double ball bearing raceways on 4" & 5" models
 - Very Positive swivel lock—operates independently of the wheel brake, reducing wear and tendency to ratchet
 - Precision ball bearings in wheels for easier rollability
 - Wheels are crowned for easy rolling and turning
 - Swivel rigs have a bright chrome finish
 - Cam-hole orientation to customer specification - can be in direction of travel, or 90 degrees to direction of travel.
 - Factory-set mechanism, maintenance-free for the life of the caster
 - Stem with 4 x M8 fixing holes to suit all bed layouts and reduce extra inventory needs.

Our new central locking brake design provides a more positive wheel lock with more surface contact on the wheel. Caster meets ISO Standard 22882: 2004 Casters & Wheels - Requirements for Casters for Hospital Beds.

CENTRAL LOCKING TOTAL LOCK

Wheel Diameter Inches (mm)	Tread Width (Inches)	Wheel Description	Capacity (Lbs)	Load Height Inches (mm)	Swivel Radius Inches (mm)	Wheel Bearing	Model Number
4" (100)	1-1/4	Thermoplastic Rubber	175	5-7/16" (138)	3-15/32" (88)	Precision Ball	MB-04TPP-125-TL-___
5" (125)	1-1/4	Thermoplastic Rubber	220	6-27/64"(163)	3-37/64" (91)	Precision Ball	MB-05TPP-125-TL-___
8" (200)	1-1/4	Thermoplastic Rubber	330	9-7/16" (240)	6-3/8" (162)	Precision Ball	MB-08TPP-125-TL-___

CENTRAL LOCKING RUBBER DIRECTIONAL AND TOTAL LOCK COMBO

4" (100)	1-1/4	Thermoplastic Rubber	175	5-7/16" (138)	3-15/32" (88)	Precision Ball	MB-04TPP-125-DT-___
5" (125)	1-1/4	Thermoplastic Rubber	220	6-27/64"(163)	3-37/64" (91)	Precision Ball	MB-05TPP-125-DT-___
8" (200)	1-1/4	Thermoplastic Rubber	330	9-7/16" (240)	6-3/8" (162)	Precision Ball	MB-08TPP-125-DT-___

FREE SWIVEL MODELS

4" (100)	1-1/4	Thermoplastic Rubber	175	5-7/16" (138)	3-15/32" (88)	Precision Ball	MB-04TPP-125-SW-___
5" (125)	1-1/4	Thermoplastic Rubber	220	6-27/64"(163)	3-37/64" (91)	Precision Ball	MB-05TPP-125-SW-___
8" (200)	1-1/4	Thermoplastic Rubber	330	9-7/16" (240)	6-3/8" (162)	Precision Ball	MB-08TPP-125-DT-___

Locking Models

M8 threaded holes for fitting either in the direction of travel or 90 degrees to direction of travel

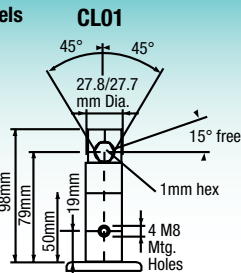

CL02

M6 threaded holes for fitting either in the direction of travel.

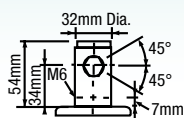

Free Swivel Models



27.8mm x 45mm for tubular frame with 28mm ID



32mm x 54mm For tubular frame with 32mm ID

HOSPITAL BED PLASTIC (HP)

FREE SWIVEL • TOTAL LOCK • TOTAL/DIRECTION LOCK COMBO



APPLICATIONS

- Hospital Beds
- Stretchers

FEATURES

- Molded nylon with glass filler support
- Swivel, total lock and direction lock + total lock models available
- Available in grey finish
- Available with santoprene rubber, polyurethane and anti-static wheels
- Wheels are Non-marking
- Swivel raceway has sealed precision bearing for smooth easy swiveling
- Wheels are provided with sealed Precision bearing and full thread guards
- Resistant to many cleaning and disinfectant solutions
- M6 or M8 threaded holes for fitting either in the direction of travel or 90 degrees to direction of travel
- Cam holes are 90 degrees to direction of travel

HP hospital bed casters are molded nylon with glass filler support. Wheels and swivel feature precision bearing for smooth operation.

CENTRAL LOCKING FREE SWIVEL MODELS

Wheel Diameter Inches (mm)	Tread Width (Inches)	Wheel Description	Capacity (Lbs)	Load Height Inches (mm)	Swivel Radius Inches (mm)	Wheel Bearing	Model Number
4" (100)	1-1/4	Rubber on Plastic	198	5-45/64" (145)	3-15/32" (88)	Precision Ball	HP-04RPP-125-SW-____
4" (100)	1-1/4	Polyurethane	198	5-45/64" (145)	3-15/32" (88)	Precision Ball	HP-04PYP-125-SW-____
5" (125)	1-1/4	Rubber on Plastic	220	6-1/2" (165)	4-5/16" (109)	Precision Ball	HP-05RPP-125-SW-____
5" (125)	1-1/4	Polyurethane	220	6-1/2" (165)	4-5/16" (109)	Precision Ball	HP-05PYP-125-SW-____
6" (150)	1-1/4	Rubber on Plastic	220	7-43/64" (195)	4-5/16" (109)	Precision Ball	HP-06RPP-125-SW-____
6" (150)	1-1/4	Polyurethane	220	7-43/64" (195)	4-5/16" (109)	Precision Ball	HP-06PYP-125-SW-____
8" (200)	1-1/4	Rubber on Plastic	264	9-57/64" (251)	6-37/64" (167)	Precision Ball	HP-08RPP-125-SW-____
8" (200)	1-1/4	Polyurethane	264	9-57/64" (251)	6-37/64" (167)	Precision Ball	HP-08PYP-125-SW-____

See total lock and direction lock models on next page

Free Swivel Models (Total/Direction next page)

RS03



27.8mm x 45mm for tubular frame with 28mm ID

RS05



32mm x 54mm For tubular frame with 32mm ID

HOSPITAL BED PLASTIC (HP)

FREE SWIVEL • TOTAL LOCK •
TOTAL/DIRECTION LOCK COMBO

CENTRAL LOCKING TOTAL LOCK MODELS

Wheel Diameter Inches (mm)	Tread Width (Inches)	Wheel Description	Capacity (Lbs)	Load Height Inches (mm)	Swivel Radius Inches (mm)	Wheel Bearing	Model Number
4" (100)	1-1/4	Rubber on Plastic	198	5-45/64" (145)	3-15/32" (88)	Precision Ball	HP-04RPP-125-TL-____
4" (100)	1-1/4	Polyurethane	198	5-45/64" (145)	3-15/32" (88)	Precision Ball	HP-04PYP-125-TL-____
5" (125)	1-1/4	Rubber on Plastic	220	6-1/2" (165)	4-5/16" (109)	Precision Ball	HP-05RPP-125-TL-____
5" (125)	1-1/4	Polyurethane	220	6-1/2" (165)	4-5/16" (109)	Precision Ball	HP-05PYP-125-TL-____
6" (150)	1-1/4	Rubber on Plastic	220	7-43/64" (195)	4-57/64" (124)	Precision Ball	HP-06RPP-125-TL-____
6" (150)	1-1/4	Polyurethane	220	7-43/64" (195)	4-57/64" (124)	Precision Ball	HP-06PYP-125-TL-____
8" (200)	1-1/4	Rubber on Plastic	264	9-57/64" (251)	6-37/64" (167)	Precision Ball	HP-08RPP-125-TL-____
8" (200)	1-1/4	Polyurethane	264	9-57/64" (251)	6-37/64" (167)	Precision Ball	HP-08PYP-125-TL-____

CENTRAL LOCKING DIRECTIONAL AND TOTAL LOCK COMBO

Wheel Diameter Inches (mm)	Tread Width (Inches)	Wheel Description	Capacity (Lbs)	Load Height Inches (mm)	Swivel Radius Inches (mm)	Wheel Bearing	Model Number
4" (100)	1-1/4	Rubber on Plastic	198	5-45/64" (145)	3-15/32" (88)	Precision Ball	HP-04RPP-125-DT-____
4" (100)	1-1/4	Polyurethane	198	5-45/64" (145)	3-15/32" (88)	Precision Ball	HP-04PYP-125-DT-____
5" (125)	1-1/4	Rubber on Plastic	220	6-1/2" (165)	4-5/16" (109)	Precision Ball	HP-05RPP-125-DT-____
5" (125)	1-1/4	Polyurethane	220	6-1/2" (165)	4-5/16" (109)	Precision Ball	HP-05PYP-125-DT-____
6" (150)	1-1/4	Rubber on Plastic	220	7-43/64" (195)	4-57/64" (124)	Precision Ball	HP-06RPP-125-DT-____
6" (150)	1-1/4	Polyurethane	220	7-43/64" (195)	4-57/64" (124)	Precision Ball	HP-06PYP-125-DT-____
8" (200)	1-1/4	Rubber on Plastic	264	9-57/64" (251)	6-37/64" (167)	Precision Ball	HP-08RPP-125-DT-____
8" (200)	1-1/4	Polyurethane	264	9-57/64" (251)	6-37/64" (167)	Precision Ball	HP-08PYP-125-DT-____

Locking Models

CL01

M8 threaded holes for fitting either in the direction of travel or 90 degrees to direction of travel

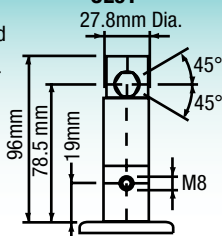

CL02

M6 threaded holes for fitting either in the direction of travel.

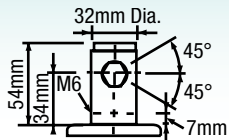

HOSPITAL BED CHROME (HC)

FREE SWIVEL • TOTAL LOCK • TOTAL/DIRECTION LOCK COMBO



APPLICATIONS

- Hospital Beds
- Stretchers

FEATURES

- Bright Chrome Finish
- Wheels are non-marking
- Swivel, total lock and direction lock + total lock models available
- Available with santoprene rubber, polyurethane and anti-static wheels
- Resistant to many cleaning and disinfectant solutions
- Swivel raceway has sealed precision bearing for smooth easy swiveling
- Wheels are provided with sealed precision bearings for easy rolling
- Wheels feature full thread Guards
- M8 threaded holes for fitting either in the direction of travel or 90 degrees to direction of travel

HC hospital bed chrome casters feature attractive bright chrome finish. Wheels and swivel feature precision bearing for smooth operation.

CENTRAL LOCKING FREE SWIVEL MODELS

Wheel Diameter Inches (mm)	Tread Width (Inches)	Wheel Description	Capacity (Lbs)	Load Height (Inches)	Swivel Radius (Inches)	Wheel Bearing	Model Number
4" (100)	1-1/4	Rubber on Plastic	220	5-29/32" (150)	3-45/64" (94)	Precision Ball	HC-04RPP-125-SW-___
4" (100)	1-1/4	Polyurethane	220	5-29/32" (150)	3-45/64" (94)	Precision Ball	HC-04PYP-125-SW-___
4" (100)	1-1/4	Polyurethane Anti-static	220	5-29/32" (150)	3-45/64" (94)	Precision Ball	HC-04APP-125-SW-___
5" (125)	1-1/4	Rubber on Plastic	220	6-57/64" (175)	4-15/64" (107)	Precision Ball	HC-05RPP-125-SW-___
5" (125)	1-1/4	Polyurethane	220	6-57/64" (175)	4-15/64" (107)	Precision Ball	HC-05PYP-125-SW-___
5" (125)	1-1/4	Polyurethane Anti-static	220	6-57/64" (175)	4-15/64" (107)	Precision Ball	HC-05APP-125-SW-___
6" (150)	1-1/4	Rubber on Plastic	240	7-7/8" (200)	4-31/32" (126)	Precision Ball	HC-06RPP-125-SW-___
6" (150)	1-1/4	Polyurethane	240	7-7/8" (200)	4-31/32" (126)	Precision Ball	HC-06PYP-125-SW-___
6" (150)	1-1/4	Polyurethane Anti-static	240	7-7/8" (200)	4-31/32" (126)	Precision Ball	HC-06APP-125-SW-___
8" (200)	1-1/4	Rubber on Plastic	264	9-27/32" (250)	6-1/16" (154)	Precision Ball	HC-08RPP-125-SW-___
8" (200)	1-1/4	Polyurethane	264	9-27/32" (250)	6-1/16" (154)	Precision Ball	HC-08PYP-125-SW-___
8" (200)	1-1/4	Polyurethane Anti-static	264	9-27/32" (250)	6-1/16" (154)	Precision Ball	HC-08APP-125-SW-___

See total lock and direction lock models on next page

Free Swivel Models (Total/Direction next page)

RS03



27.8mm x 45mm for tubular frame with 28mm ID

RS05



32mm x 54mm For tubular frame with 32mm ID

HOSPITAL BED CHROME (HC)

FREE SWIVEL • TOTAL LOCK •
TOTAL/DIRECTION LOCK COMBO

CENTRAL LOCKING TOTAL LOCK MODELS

Wheel Diameter Inches (mm)	Tread Width (Inches)	Wheel Description	Capacity (Lbs)	Load Height (Inches)	Swivel Radius (Inches)	Wheel Bearing	Model Number
4" (100)	1-1/4	Rubber on Plastic	220	5-29/32" (150)	3-45/64" (94)	Precision Ball	HC-04RPP-125-TL-_____
4" (100)	1-1/4	Polyurethane	220	5-29/32" (150)	3-45/64" (94)	Precision Ball	HC-04PYP-125-TL-_____
4" (100)	1-1/4	Polyurethane Anti-static	220	5-29/32" (150)	3-45/64" (94)	Precision Ball	HC-04APP-125-TL-_____
5" (125)	1-1/4	Rubber on Plastic	220	6-57/64" (175)	4-15/64" (107)	Precision Ball	HC-05RPP-125-TL-_____
5" (125)	1-1/4	Polyurethane	220	6-57/64" (175)	4-15/64" (107)	Precision Ball	HC-05PYP-125-TL-_____
5" (125)	1-1/4	Polyurethane Anti-static	220	6-57/64" (175)	4-15/64" (107)	Precision Ball	HC-05APP-125-TL-_____
6" (150)	1-1/4	Rubber on Plastic	240	7-7/8" (200)	4-31/32" (126)	Precision Ball	HC-06RPP-125-TL-_____
6" (150)	1-1/4	Polyurethane	240	7-7/8" (200)	4-31/32" (126)	Precision Ball	HC-06PYP-125-TL-_____
6" (150)	1-1/4	Polyurethane Anti-static	240	7-7/8" (200)	4-31/32" (126)	Precision Ball	HC-06APP-125-TL-_____
8" (200)	1-1/4	Rubber on Plastic	264	9-27/32" (250)	6-1/16" (154)	Precision Ball	HC-08RPP-125-TL-_____
8" (200)	1-1/4	Polyurethane	264	9-27/32" (250)	6-1/16" (154)	Precision Ball	HC-08PYP-125-TL-_____
8" (200)	1-1/4	Polyurethane Anti-static	264	9-27/32" (250)	6-1/16" (154)	Precision Ball	HC-08APP-125-TL-_____

CENTRAL LOCKING DIRECTIONAL AND TOTAL LOCK COMBO

Wheel Diameter Inches (mm)	Tread Width (Inches)	Wheel Description	Capacity (Lbs)	Load Height (Inches)	Swivel Radius (Inches)	Wheel Bearing	Model Number
4" (100)	1-1/4	Rubber on Plastic	220	5-29/32" (150)	3-45/64" (94)	Precision Ball	HC-04RPP-125-DT-_____
4" (100)	1-1/4	Polyurethane	220	5-29/32" (150)	3-45/64" (94)	Precision Ball	HC-04PYP-125-DT-_____
4" (100)	1-1/4	Polyurethane Anti-static	220	5-29/32" (150)	3-45/64" (94)	Precision Ball	HC-04APP-125-DT-_____
5" (125)	1-1/4	Rubber on Plastic	220	6-57/64" (175)	4-15/64" (107)	Precision Ball	HC-05RPP-125-DT-_____
5" (125)	1-1/4	Polyurethane	220	6-57/64" (175)	4-15/64" (107)	Precision Ball	HC-05PYP-125-DT-_____
5" (125)	1-1/4	Polyurethane Anti-static	220	6-57/64" (175)	4-15/64" (107)	Precision Ball	HC-05APP-125-DT-_____
6" (150)	1-1/4	Rubber on Plastic	240	7-7/8" (200)	4-31/32" (126)	Precision Ball	HC-06RPP-125-DT-_____
6" (150)	1-1/4	Polyurethane	240	7-7/8" (200)	4-31/32" (126)	Precision Ball	HC-06PYP-125-DT-_____
6" (150)	1-1/4	Polyurethane Anti-static	240	7-7/8" (200)	4-31/32" (126)	Precision Ball	HC-06APP-125-DT-_____
8" (200)	1-1/4	Rubber on Plastic	264	9-27/32" (250)	6-1/16" (154)	Precision Ball	HC-08RPP-125-DT-_____
8" (200)	1-1/4	Polyurethane	264	9-27/32" (250)	6-1/16" (154)	Precision Ball	HC-08PYP-125-DT-_____
8" (200)	1-1/4	Polyurethane Anti-static	264	9-27/32" (250)	6-1/16" (154)	Precision Ball	HC-08APP-125-DT-_____

Locking Models

M8 threaded holes for fitting either in the direction of travel or 90 degrees to direction of travel

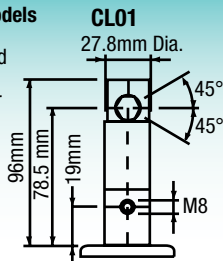

CL02

M6 threaded holes for fitting either in the direction of travel.

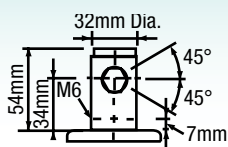

HOSPITAL BED STAINLESS (HS)

FREE SWIVEL • TOTAL LOCK • TOTAL/DIRECTION LOCK COMBO

APPLICATIONS

- Hospital Beds
- Stretchers

FEATURES

- Stainless Steel 304 Finish
- Wheels are Non-marking
- Swivel, total lock and direction lock + total lock models available
- Resistant to many cleaning and disinfectant solutions
- Wheels are provided with sealed precision bearings for easy rolling
- Wheels feature full thread guards
- Swivel raceway has sealed precision bearing for smooth easy swiveling
- Available with santoprene rubber, polyurethane and anti-static wheels
- Central Locking Stem and brake mechanism have Zinc Finish
- M8 threaded holes for fitting either in the direction of travel or 90 degrees to direction of travel



HS hospital bed chrome casters feature attractive 304 stainless steel. Wheels and swivel feature precision bearing for smooth operation.

CENTRAL LOCKING FREE SWIVEL MODELS

Wheel Diameter Inches (mm)	Tread Width (Inches)	Wheel Description	Capacity (Lbs)	Load Height (Inches)	Swivel Radius (Inches)	Wheel Bearing	Model Number
4" (100)	1-1/4	Rubber on Plastic	220	5-29/32" (150)	3-45/64" (94)	Precision Ball	HS-04RPP-125-SW-___
4" (100)	1-1/4	Polyurethane	220	5-29/32" (150)	3-45/64" (94)	Precision Ball	HS-04PYP-125-SW-___
4" (100)	1-1/4	Polyurethane Anti-static	220	5-29/32" (150)	3-45/64" (94)	Precision Ball	HS-04APP-125-SW-___
5" (125)	1-1/4	Rubber on Plastic	220	6-57/64" (175)	4-15/64" (107)	Precision Ball	HS-05RPP-125-SW-___
5" (125)	1-1/4	Polyurethane	220	6-57/64" (175)	4-15/64" (107)	Precision Ball	HS-05PYP-125-SW-___
5" (125)	1-1/4	Polyurethane Anti-static	220	6-57/64" (175)	4-15/64" (107)	Precision Ball	HS-05APP-125-SW-___
6" (150)	1-1/4	Rubber on Plastic	240	7-7/8" (200)	4-31/32" (126)	Precision Ball	HS-06RPP-125-SW-___
6" (150)	1-1/4	Polyurethane	240	7-7/8" (200)	4-31/32" (126)	Precision Ball	HS-06PYP-125-SW-___
6" (150)	1-1/4	Polyurethane Anti-static	240	7-7/8" (200)	4-31/32" (126)	Precision Ball	HS-06APP-125-SW-___
8" (200)	1-1/4	Rubber on Plastic	264	9-27/32" (250)	6-1/16" (154)	Precision Ball	HS-08RPP-125-SW-___
8" (200)	1-1/4	Polyurethane	264	9-27/32" (250)	6-1/16" (154)	Precision Ball	HS-08PYP-125-SW-___
8" (200)	1-1/4	Polyurethane Anti-static	264	9-27/32" (250)	6-1/16" (154)	Precision Ball	HS-08APP-125-SW-___

Free Swivel Models (Total/Direction next page)

RS03



27.8mm x 45mm
for tubular frame
with 28mm ID

RS05



32mm x 54mm
For tubular frame
with 32mm ID

See total lock and
direction lock models
on next page

HOSPITAL BED STAINLESS (HS)

FREE SWIVEL • TOTAL LOCK •
TOTAL/DIRECTION LOCK COMBO

CENTRAL LOCKING TOTAL LOCK MODELS

Wheel Diameter Inches (mm)	Tread Width (Inches)	Wheel Description	Capacity (Lbs)	Load Height (Inches)	Swivel Radius (Inches)	Wheel Bearing	Model Number
4" (100)	1-1/4	Rubber on Plastic	220	5-29/32" (150)	3-45/64" (94)	Precision Ball	HS-04RPP-125-TL-_____
4" (100)	1-1/4	Polyurethane	220	5-29/32" (150)	3-45/64" (94)	Precision Ball	HS-04PYP-125-TL-_____
4" (100)	1-1/4	Polyurethane Anti-static	220	5-29/32" (150)	3-45/64" (94)	Precision Ball	HS-04APP-125-TL-_____
5" (125)	1-1/4	Rubber on Plastic	220	6-57/64" (175)	4-15/64" (107)	Precision Ball	HS-05RPP-125-TL-_____
5" (125)	1-1/4	Polyurethane	220	6-57/64" (175)	4-15/64" (107)	Precision Ball	HS-05PYP-125-TL-_____
5" (125)	1-1/4	Polyurethane Anti-static	220	6-57/64" (175)	4-15/64" (107)	Precision Ball	HS-05APP-125-TL-_____
6" (150)	1-1/4	Rubber on Plastic	240	7-7/8" (200)	4-31/32" (126)	Precision Ball	HS-06RPP-125-TL-_____
6" (150)	1-1/4	Polyurethane	240	7-7/8" (200)	4-31/32" (126)	Precision Ball	HS-06PYP-125-TL-_____
6" (150)	1-1/4	Polyurethane Anti-static	240	7-7/8" (200)	4-31/32" (126)	Precision Ball	HS-06APP-125-TL-_____
8" (200)	1-1/4	Rubber on Plastic	264	9-27/32" (250)	6-1/16" (154)	Precision Ball	HS-08RPP-125-TL-_____
8" (200)	1-1/4	Polyurethane	264	9-27/32" (250)	6-1/16" (154)	Precision Ball	HS-08PYP-125-TL-_____
8" (200)	1-1/4	Polyurethane Anti-static	264	9-27/32" (250)	6-1/16" (154)	Precision Ball	HS-08APP-125-TL-_____

CENTRAL LOCKING DIRECTIONAL AND TOTAL LOCK COMBO

Wheel Diameter Inches (mm)	Tread Width (Inches)	Wheel Description	Capacity (Lbs)	Load Height (Inches)	Swivel Radius (Inches)	Wheel Bearing	Model Number
4" (100)	1-1/4	Rubber on Plastic	220	5-29/32" (150)	3-45/64" (94)	Precision Ball	HS-04RPP-125-DT-_____
4" (100)	1-1/4	Polyurethane	220	5-29/32" (150)	3-45/64" (94)	Precision Ball	HS-04PYP-125-DT-_____
4" (100)	1-1/4	Polyurethane Anti-static	220	5-29/32" (150)	3-45/64" (94)	Precision Ball	HS-04APP-125-DT-_____
5" (125)	1-1/4	Rubber on Plastic	220	6-57/64" (175)	4-15/64" (107)	Precision Ball	HS-05RPP-125-DT-_____
5" (125)	1-1/4	Polyurethane	220	6-57/64" (175)	4-15/64" (107)	Precision Ball	HS-05PYP-125-DT-_____
5" (125)	1-1/4	Polyurethane Anti-static	220	6-57/64" (175)	4-15/64" (107)	Precision Ball	HS-05APP-125-DT-_____
6" (150)	1-1/4	Rubber on Plastic	240	7-7/8" (200)	4-31/32" (126)	Precision Ball	HS-06RPP-125-DT-_____
6" (150)	1-1/4	Polyurethane	240	7-7/8" (200)	4-31/32" (126)	Precision Ball	HS-06PYP-125-DT-_____
6" (150)	1-1/4	Polyurethane Anti-static	240	7-7/8" (200)	4-31/32" (126)	Precision Ball	HS-06APP-125-DT-_____
8" (200)	1-1/4	Rubber on Plastic	264	9-27/32" (250)	6-1/16" (154)	Precision Ball	HS-08RPP-125-DT-_____
8" (200)	1-1/4	Polyurethane	264	9-27/32" (250)	6-1/16" (154)	Precision Ball	HS-08PYP-125-DT-_____
8" (200)	1-1/4	Polyurethane Anti-static	264	9-27/32" (250)	6-1/16" (154)	Precision Ball	HS-08APP-125-DT-_____

Locking Models

M8 threaded holes for fitting either in the direction of travel or 90 degrees to direction of travel

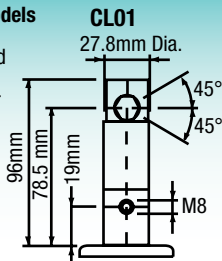

CL02

M6 threaded holes for fitting either in the direction of travel.

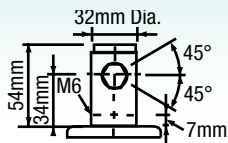

MED-ULTRA (MU)

FREE SWIVEL • TOTAL LOCK • TOTAL/DIRECTION LOCK COMBO



APPLICATIONS

- Hospital Beds
- Stretchers
- Ultrasonic Equipment

FEATURES

- Precision bearings in wheels
- Caster meets ISO Standard 22882: 2004 Caster & Wheels - Requirements for Casters for Hospital Beds.
- Central-locking brake design has very Positive swivel lock - operates independently of the wheel brake, reducing wear and tendency to ratchet
- Wheel brake can be applied dynamically without damage to mechanism.
- Factory-set mechanism, maintenance-free for the life of the caster
- Stem with 4 x M8 fixing holes to suit all bed layouts and reduce stock holding.

Dual wheel design improves turning. Our new central locking brake design provides a more positive wheel lock with more surface contact on the wheel. Caster meets ISO Standard 22882: 2004 Casters & Wheels - Requirements for Casters for Hospital Beds.

Wheel Diameter Inches (mm)	Tread Width Inches (mm)	Wheel Description	Capacity (Lbs)	Load Height Inches (mm)	Swivel Lead Inches (mm)	Wheel Bearing	Model Number
CENTRAL LOCKING TOTAL LOCK MODELS							
5" (125)	2-1/2"(65)	Polyurethane Gray	352	6-1/64" (153)	1-37/64" (40)	Precision Ball	MU-05PYP-283-TL-____
5" (125)	2-1/2"(65)	Polyurethane Anti-Static	352	6-1/64" (153)	1-37/64" (40)	Precision Ball	MU-05APP-283-TL-____
6" (150)	3-5/32"(80)	Polyurethane Gray	484	7-1/16" (179)	1-25/32" (45)	Precision Ball	MU-06PYP-283-TL-____
6" (150)	3-5/32"(80)	Polyurethane Anti-Static	484	7-1/16" (179)	1-25/32" (45)	Precision Ball	MU-06APP-283-TL-____

CENTRAL LOCKING DIRECTIONAL AND TOTAL LOCK COMBO

5" (127)	2-1/2"(65)	Polyurethane Gray	352	6-1/64" (153)	1-37/64" (40)	Precision Ball	MU-05PYP-283-DT-____
5" (127)	2-1/2"(65)	Polyurethane Anti-Static	352	6-1/64" (153)	1-37/64" (40)	Precision Ball	MU-05APP-283-DT-____
6" (150)	3-5/32"(80)	Polyurethane Gray	484	7-1/16" (179)	1-25/32" (45)	Precision Ball	MU-06PYP-283-DT-____
6" (150)	3-5/32"(80)	Polyurethane Anti-Static	484	7-1/16" (179)	1-25/32" (45)	Precision Ball	MU-06APP-283-DT-____

FREE SWIVEL MODELS

5" (127)	2-1/2"(65)	Polyurethane Gray	352	6-1/64" (153)	1-37/64" (40)	Precision Ball	MU-05PYP-283-SW-____
5" (127)	2-1/2"(65)	Polyurethane Anti-Static	352	6-1/64" (153)	1-37/64" (40)	Precision Ball	MU-05APP-283-SW-____
6" (150)	3-5/32"(80)	Polyurethane Gray	484	7-1/16" (179)	1-25/32" (45)	Precision Ball	MU-06PYP-283-SW-____
6" (150)	3-5/32"(80)	Polyurethane Anti-Static	484	7-1/16" (179)	1-25/32" (45)	Precision Ball	MU-06APP-283-SW-____

Locking Models

M8 threaded holes for fitting either in the direction of travel or 90 degrees to direction of travel

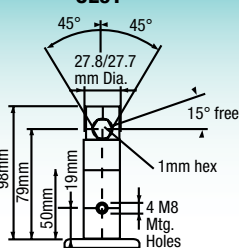

CL02

M6 threaded holes for fitting either in the direction of travel.

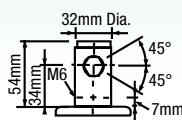

Free Swivel Models



27.8mm x 45mm for tubular frame with 28mm ID



32mm x 54mm For tubular frame with 32mm ID

SOLUS TECH (ST)

FREE SWIVEL • TOTAL LOCK • DIRECTION LOCK



APPLICATIONS

- Medical and diagnostic equipment
- Computer equipment
- Electronic equipment
- High-tech products

Special colors available. Consult factory.

FEATURES

- Foot brake easily engaged; mechanically locks both swivel and wheel rotation
- Aluminum shell hides nuts and bolts
- Quiet operation
- Precision axle built to exacting tolerance for smooth operation and extended life
- Precision bearings reduce maintenance and improve maneuverability
- Choose from a wide variety of colors--minimum quantities required
- Polyurethane tires can be molded in a variety of colors, hardness
- Caster construction for non-magnetic characteristics
- Antistatic rubber, nylon, or polyurethane wheels

The unique shell design of the Solus Tech helps keep dirt out of the internal mechanism of the caster for a long service life. For routine maintenance, the outer shell can be removed from the caster for access to the internal braking mechanism.

FREE SWIVEL MODELS

Wheel Diameter (Inches)	Tread Width (Inches)	Wheel Description	Capacity (lbs)	Load Height Inches (mm)	Swivel Lead Inches (mm)	Wheel Bearing	Model Number
4	1-15/32	Polyurethane Gray	175	5-19/32" (142)	3-15/16" (100)	Precision Ball	ST-04PYP-150-SW-TS15
5	1-15/32	Polyurethane Gray	220	6-13/16" (173)	4-15/16" (125)	Precision Ball	ST-05PYP-150-SW-TS16

TOTAL LOCK MODELS

4	1-15/32	Polyurethane Gray	175	5-19/32" (142)	3-15/16" (100)	Precision Ball	ST-04PYP-150-TL-TS15
5	1-15/32	Polyurethane Gray	220	6-13/16" (173)	4-15/16" (125)	Precision Ball	ST-05PYP-150-TL-TS16

DIRECTION LOCK MODELS

4	1-15/32	Polyurethane Gray	175	5-19/32" (142)	3-15/16" (100)	Precision Ball	ST-04PYP-150-DL-TS15
5	1-15/32	Polyurethane Gray	220	6-13/16" (173)	4-15/16" (125)	Precision Ball	ST-05PYP-150-DL-TS16

THREADED STEM FITTINGS

Easy to install stem. See fittings page for more options.

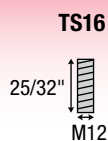
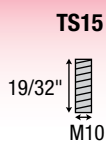

WHEELS

NEOTEQ (CN)



- **Tread:** Neoprene Rubber
- **Core:** Chrome Thread Guard
- **Temperature Range:** -30°F to +175°F
- **Hardness:** 70 (±5) Shore A

Wheel Diameter (Inches)	Tread Width (Inches)	Capacity (Lbs)	Bearing	Fits Axle Size (Inches)	Model Number
2	1	125	Precision Ball	5/16	CN-02NRP-100-05
3	1	175	Precision Ball	5/16	CN-03NRP-100-05

RAZER (RZ)

GREY TPR



- **Tread:** TPR
- **Side:** Metal Thread Guard
- **Temperature Range:** -30°F to +180°F
- **Hardness:** 85 (±5) Shore A

Wheel Diameter (Inches)	Tread Width (Inches)	Capacity (Lbs)	Bearing	Fits Axle Size (Inches)	Model Number
2	3/4	110	Plain	5/16	RZ-02TPN-070-05
3	7/8	140	Ball	5/16	RZ-03TPP-090-05
4	7/8	160	Ball	5/16	RZ-04TPP-090-05
5	7/8	165	Ball	5/16	RZ-05TPP-090-05

CHROME HOSPITAL (CH), CHROME STEEL (CS), STAINLESS STEEL (SS)

THERMOPLASTIC RUBBER



- **Tread:** TPR
- **Side:** Plastic Thread Guard
- **Temperature Range:** -30°F to +210°F
- **Hardness:** 85 (±5) Shore A

Wheel Diameter (Inches)	Tread Width (Inches)	Capacity (Lbs)	Bearing	Fits Axle Size (Inches)	Model Number
3	1-1/4	165	Precision Ball	5/16	CH-03TPP-125-05
4	1-1/4	190	Precision Ball	5/16	CH-03TPP-125-05
5	1-1/4	220	Precision Ball	5/16	CH-05TPP-125-05
6	1-1/4	240	Precision Ball	5/16	CH-03TPP-125-05

ANTI-MICROBIAL TPR



- **Tread:** Anti-microbial TPR
- **Side:** Plastic Thread Guard
- **Temperature Range:** -30°F to +210°F
- **Hardness:** 85 (±5) Shore A

Wheel Diameter (Inches)	Tread Width (Inches)	Capacity (Lbs)	Bearing	Fits Axle Size (Inches)	Model Number
3	1-1/4	165	Precision Ball	5/16	CH-03AMP-125-05
4	1-1/4	190	Precision Ball	5/16	CH-04AMP-125-05
5	1-1/4	220	Precision Ball	5/16	CH-05AMP-125-05
6	1-1/4	240	Precision Ball	5/16	CH-06AMP-125-05

NEOPRENE RUBBER



- **Tread:** Neoprene
- **Side:** Plastic Thread Guard
- **Temperature Range:** -30°F to +175°F
- **Hardness:** 70 (±5) Shore A

Wheel Diameter (Inches)	Tread Width (Inches)	Capacity (Lbs)	Bearing	Fits Axle Size (Inches)	Model Number
4	1-1/4	250	Precision Ball	5/16	CH-04NRP-125-05
4	1-1/4	250	Precision Ball	3/8	CH-04NRP-125-06
5	1-1/4	300	Precision Ball	5/16	CH-05NRP-125-05
5	1-1/4	300	Precision Ball	3/8	CH-05NRP-125-06

POLYURETHANE TPU



- **Tread:** TPR Polyurethane
- **Side:** Plastic Thread Guard
- **Temperature Range:** -30°F to +180°F
- **Hardness:** 95 (±5) Shore A

Wheel Diameter (Inches)	Tread Width (Inches)	Capacity (Lbs)	Bearing	Fits Axle Size (Inches)	Model Number
3	1-1/4	165	Precision Ball	5/16	CH-03TPP-125-05
4	1-1/4	190	Precision Ball	5/16	CH-04TPP-125-05
5	1-1/4	220	Precision Ball	5/16	CH-05TPP-125-05
6	1-1/4	240	Precision Ball	5/16	CH-06TPP-125-05

WHEELS

NYLON (NG) AND NYLON PLUS STAINLESS (NS)

QUICKSTART TPR



- **Tread:** TPR
- **Side:** Integrated Thread Guard
- **Temperature Range:** -30°F to +180°F
- **Hardness:** 70 (±5) Shore A

Wheel Diameter (Inches)	Tread Width (Inches)	Capacity (Lbs)	Bearing	Fits Axle Size (Inches)	Model Number
3	1-1/4	200	Precision Ball	5/16	NG-03QDP-125-05
4	1-1/4	275	Precision Ball	5/16	NG-04QDP-125-05
5	1-1/4	325	Precision Ball	5/16	NG-05QDP-125-05
6	1-1/4	325	Precision Ball	5/16	NG-06QDP-125-05

ANTI-MICROBIAL TPR



- **Tread:** Antimicrobial TPR
- **Side:** Integrated Thread Guard
- **Temperature Range:** -30°F to +180°F
- **Hardness:** 70 (±5) Shore A

Wheel Diameter (Inches)	Tread Width (Inches)	Capacity (Lbs)	Bearing	Fits Axle Size (Inches)	Model Number
3	1-1/4	200	Precision Ball	5/16	NG-03AMP-125-05
4	1-1/4	275	Precision Ball	5/16	NG-04AMP-125-05
5	1-1/4	325	Precision Ball	5/16	NG-05AMP-125-05
6	1-1/4	325	Precision Ball	5/16	NG-06AMP-125-05

PLASTIC (PG)

RUBBER ON PLASTIC



- **Tread:** Rubber/Santoprene
- **Side:** Integrated Thread Guard
- **Temperature Range:** -30°F to +210°F
- **Hardness:** 85 (±5) Shore A

Wheel Diameter (Inches)	Tread Width (Inches)	Capacity (Lbs)	Bearing	Fits Axle Size (Inches)	Model Number
4	1-1/4	220	Precision Ball	5/16	PG-04RPP-125-05
5	1-1/4	220	Precision Ball	5/16	PG-05RPP-125-05
6	1-1/4	264	Precision Ball	5/16	PG-06RPP-125-05
8	1-1/4	264	Precision Ball	5/16	PG-08RPP-125-05

ANTI-STATIC PLASTIC (PA)

ANTI-STATIC POLYURETHANE TPU



- **Tread:** Polyurethane
- **Side:** Plastic Thread Guard
- **Temperature Range:** -30°F to +180°F
- **Hardness:** 95 (±5) Shore A

Wheel Diameter (Inches)	Tread Width (Inches)	Capacity (Lbs)	Bearing	Fits Axle Size (Inches)	Model Number
4	1-1/4	220	Precision Ball	5/16	PA-04APP-125-05
5	1-1/4	220	Precision Ball	5/16	PA-05APP-125-05
6	1-1/4	264	Precision Ball	5/16	PA-06APP-125-05
8	1-1/4	264	Precision Ball	5/16	PA-08APP-125-05

HOSPITAL BED REPLACEMENT WHEELS

HOSPITAL BED REPLACEMENT WHEELS (HP)

RUBBER ON PLASTIC



- **Tread:** Rubber
- **Side:** Integrated Thread Guard
- **Temperature Range:** -30°F to +160°F
- **Hardness:** 85 (±5) Shore A

Wheel Diameter (Inches)	Tread Width (Inches)	Capacity (Lbs)	Bearing	Fits Axle Size (Inches)	Model Number
4	1-1/4	198	Precision Ball	5/16	HP-04RPP-125-05
5	1-1/4	220	Precision Ball	5/16	HP-05RPP-125-05
6	1-1/4	220	Precision Ball	5/16	HP-06RPP-125-05
8	1-1/4	264	Precision Ball	5/16	HP-08RPP-125-05

POLYURETHANE



- **Tread:** Polyurethane
- **Side:** Integrated Thread Guard
- **Temperature Range:** -30°F to +180°F
- **Hardness:** 95 (±5) Shore A

Wheel Diameter (Inches)	Tread Width (Inches)	Capacity (Lbs)	Bearing	Fits Axle Size (Inches)	Model Number
4	1-1/4	198	Precision Ball	5/16	HP-04PYP-125-05
5	1-1/4	220	Precision Ball	5/16	HP-05PYP-125-05
6	1-1/4	220	Precision Ball	5/16	HP-06PYP-125-05
8	1-1/4	264	Precision Ball	5/16	HP-08PYP-125-05

HOSPITAL BED REPLACEMENT WHEELS (HC) AND (HS)

RUBBER ON PLASTIC



- **Tread:** Rubber
- **Side:** Bright Chrome Thread Guard
- **Temperature Range:** -30°F to +160°F
- **Hardness:** 85 (±5) Shore A

Wheel Diameter (Inches)	Tread Width (Inches)	Capacity (Lbs)	Bearing	Fits Axle Size (Inches)	Model Number
4	1-1/4	198	Precision Ball	5/16	HC-04RPP-125-05
5	1-1/4	220	Precision Ball	5/16	HC-05RPP-125-05
6	1-1/4	220	Precision Ball	5/16	HC-06RPP-125-05
8	1-1/4	264	Precision Ball	5/16	HC-08RPP-125-05

POLYURETHANE



- **Tread:** Polyurethane
- **Side:** Bright Chrome Thread Guard
- **Temperature Range:** -30°F to +180°F
- **Hardness:** 95 (±5) Shore A

Wheel Diameter (Inches)	Tread Width (Inches)	Capacity (Lbs)	Bearing	Fits Axle Size (Inches)	Model Number
4	1-1/4	198	Precision Ball	5/16	HC-04PYP-125-05
5	1-1/4	220	Precision Ball	5/16	HC-05PYP-125-05
6	1-1/4	220	Precision Ball	5/16	HC-06PYP-125-05
8	1-1/4	264	Precision Ball	5/16	HC-08PYP-125-05

POLYURETHANE ANTI-STATIC



- **Tread:** Polyurethane Anti-static (Yellow Dot)
- **Side:** Bright Chrome Thread Guard
- **Temperature Range:** -30°F to +180°F
- **Hardness:** 95 (±5) Shore A

Wheel Diameter (Inches)	Tread Width (Inches)	Capacity (Lbs)	Bearing	Fits Axle Size (Inches)	Model Number
4	1-1/4	198	Precision Ball	5/16	HC-04APP-125-05
5	1-1/4	220	Precision Ball	5/16	HC-05APP-125-05
6	1-1/4	220	Precision Ball	5/16	HC-06APP-125-05
8	1-1/4	264	Precision Ball	5/16	HC-08APP-125-05

WHEEL CHAIR CASTERS/WHEELS (WC) (WW)



APPLICATIONS

- Wheel chairs

Other sizes available. Consult factory

FEATURES

- New versatile chair replacement fork
- New front wheel chair wheels
- WC front wheel chair casters feature durable reinforced nylon construction
- Rear wheel chair casters now come in black or grey

VERSATILE FRONT WHEEL CHAIR REPLACEMENT FORK

Description	Model Number
Versatile durable light weight aluminum design fits wheels from 6" to 12" diameter wheels. Three holes allow you to choose the appropriate axle installation for desired wheel diameter. Designed for 2" tread width or less. 1/2" diameter threaded stem x 2-5/8" long.	WC-8200-SW-TS22



WHEEL CHAIR REPLACEMENT WHEELS

Wheel Diameter Inches (mm)	Tread Width Inches (mm)	Wheel Description	Capacity (Lbs)	Wheel Bearing	Fits Axle Size (mm)	Model Number
6" (150)	1-1/2" (38)	Black Polyurethane	80	Precision Ball	8mm	WW-06PBP150-8M
8" (200)	1-1/2" (38)	Grey Polyurethane	88	Precision Ball	8mm	WW-08PGP150-8M
8" (200)	2" (51)	Black Polyurethane	88	Precision Ball	8mm	WW-08PBP200-8M
12" (305)	2" (51)	Grey Polyurethane	132	Precision Ball	12mm	WW-12PGP200-12M



WC FRONT WHEEL CHAIR CASTERS

Wheel Diameter Inches (mm)	Tread Width Inches (mm)	Wheel Description	Capacity (Lbs)	Load Height Inches (mm)	Swivel Radius Inches (mm)	Wheel Bearing	Model Number
7-1/2" (190)	1-1/16" (27)	Polyurethane	88	9-1/4" (235mm)	5-1/2" (140mm)	Needle	WC-75PYR106-SW-TS17
7-7/8" (200)	1-1/16" (27)	Polyurethane	88	9-29/64" (240mm)	5-3/4" (146mm)	Needle	WC-77PYR106-SW-TS17

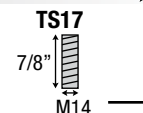

WHEEL CHAIR REAR

Wheel Diameter Inches (mm)	Tread Width Inches (mm)	Wheel Description	Capacity (Lbs)	Hub Width Inches (mm)	Bore Size (mm)	Wheel Bearing	Model Number
24" (609)	1-3/16" (30)	TPR Grey	132	2-1/8" (54)	12mm	Precision Ball	WW-024PBP118-12M
24" (609)	1-3/16" (30)	TPR Black	132	2-1/8" (54)	12mm	Precision Ball	WW-024PGP118-12M



Available in black or grey. Consult factory.

BUMPERS

CORNER BUMPERS



A heavy duty bumper with an extra rounded build-up on the apex of the corner where shocks and wear are greatest. Ends are tapered and rounded. Each side is 3" long and 1¹/₈" wide at the base.

Model Number	Thickness at Corner	Thickness at Ends	Mounting Holes
6927	1 ⁵ / ₁₆ "	1"	2 (3 ³ / ₁₆ " on each side

CORNER/ CONTINUOUS BUMPERS



Grey corner bumpers with matching strip bumpers provide 100% protection to the full perimeter of equipment. Strip bumpers are made with flat steel inserts for permanent attachment. Inserts in strip bumpers are not predrilled. They can be easily cut to size with a hacksaw and drilled as needed. Insert in corner bumper model 6926 is predrilled for mounting. Corner Bumper models 6905 and 6906 have no inserts. **Temperature Range:** -45°F to 180°F

Model Number	Inserts	Length		Width	Thickness	Mounting Holes
		Long Side	Short Side			
6926	Insert Pre-drilled	6 ³ / ₁₆ "	3 ¹ / ₁₆ "	1 ¹ / ₂ "	1 ¹ / ₈ "-1 ³ / ₄ "	2 (1 ⁷ / ₆₄ " in 6" side 1 (1 ⁷ / ₆₄ " in 3" side
9.6930	Insert	Specify (16 ft. max., 1ft. inc.)		1 ¹ / ₂ "	1"	-
66930	No Insert	Specify (50 ft. max. 1ft. inc.)		1 ¹ / ₂ "	1"	-
6906	No Insert	2 ⁵ / ₈ " each side		1 ¹ / ₈ "	1"	2 (1 ³ / ₆₄ " each side
9.6914	Insert	Specify (16 ft. max. 1ft. inc.)		1 ¹ / ₈ "	1"	-
66914	No Insert	Specify (50 ft. max. 1ft. inc.)		1 ¹ / ₈ "	1"	-
6905	No Insert	2 ¹ / ₂ " each side		3 ³ / ₄ "	3 ³ / ₄ "	2 (1 ¹ / ₈ " each side
9.6913	Insert	Specify (20 ft. max. 1ft. inc.)		3 ³ / ₄ "	5 ⁵ / ₈ "	-
66913	No insert	Specify (50 ft. max. 1ft. inc.)		3 ³ / ₄ "	5 ⁵ / ₈ "	-

END BUMPERS



Generally used on the ends of tubular handles. Available in 3¹/₄" and 1³/₄" diameters. Easily attached, they are soft enough to absorb noise and shock and hard enough to wear for years.

Model Number	Dia	Hole Dia.	Thickness
6901	3 ¹ / ₄ "	1 ¹ / ₃₂ "	7 ⁷ / ₈ "
6901.01	1 ³ / ₄ "	9 ⁹ / ₃₂ "	1 ¹ / ₂ "

SPECIALTY/CONVERSION

SPECIALTY PRODUCTS



Walker Casters and Wheels



Central Locking
Dual Wheel Caster



Streamline Medical Caster

MedCaster has a complete line of casters and wheels for the medical industry ... yet, sometimes you may need a unique solution for a caster or wheel that you cannot find. Contact us with your requirements.

INCHES TO MILLIMETERS CONVERSION

Inches (Fraction)	Inches (Decimal)	Millimeters
1/64	0.02	0.40
1/32	0.03	0.79
3/64	0.05	1.19
1/16	0.06	1.59
5/64	0.08	1.98
3/32	0.09	2.38
7/64	0.11	2.78
1/8	0.13	3.17
9/64	0.14	3.57
5/32	0.16	3.97
11/64	0.17	4.36
3/16	0.19	4.76
13/64	0.20	5.16
7/32	0.22	5.55
15/64	0.23	5.95
1/4	0.25	6.35
17/64	0.27	6.74
9/32	0.28	7.14
19/64	0.30	7.53
5/16	0.31	7.93
21/64	0.33	8.33
11/32	0.34	8.72
23/64	0.36	9.12
3/8	0.38	9.52
25/64	0.39	9.91
13/32	0.41	10.31
27/64	0.42	10.71
7/16	0.44	11.10
29/64	0.45	11.50
15/32	0.47	11.90
31/64	0.48	12.29

Inches (Fraction)	Inches (Decimal)	Millimeters
1/2	0.50	12.69
33/64	0.52	13.09
17/32	0.53	13.48
35/64	0.55	13.88
9/16	0.56	14.28
37/64	0.58	14.67
19/32	0.59	15.07
39/64	0.61	15.47
5/8	0.63	15.86
41/64	0.64	16.26
21/32	0.66	16.66
43/64	0.67	17.05
11/16	0.69	17.45
45/64	0.70	17.85
23/32	0.72	18.24
47/64	0.73	18.64
3/4	0.75	19.04
49/64	0.77	19.43
25/32	0.78	19.83
51/64	0.80	20.23
13/16	0.81	20.62
53/64	0.83	21.02
27/32	0.84	21.41
55/64	0.86	21.81
7/8	0.88	22.21
57/64	0.89	22.60
29/32	0.91	23.00
59/64	0.92	23.40
15/16	0.94	23.79
61/64	0.95	24.19
31/32	0.97	24.59
63/64	0.98	24.98

Inches (Fraction)	Inches (Decimal)	Millimeters
1	1.00	25.38
2	2.00	50.76
3	3.00	76.14
4	4.00	101.52
5	5.00	126.90
6	6.00	152.28
7	7.00	177.66
8	8.00	203.05
12	12.00	304.57

- **Convert Inches to Millimeters:**
Divide by .0394 (note: this is how above chart was calculated and rounded to hundredths)
- **Convert Millimeters to Inches:**
Multiply by .0394.
- **Convert Kilograms to Pounds:**
Multiply by 2.2046.
- **Convert Pounds to Kilograms:**
Divide by 2.2046.



MedCasterTM

WWW.MEDCASTER.COM

800 N. Clark Street • Albion, MI 49224
Phone: 866-462-9700 • Fax: 517-686-1072 • www.medcaster.com